

RENOGY REGO Series

Super Slim Solid State Lithium Battery

12.8V | 104Ah

RBT12104LFP-SSL-BT-G1

VERSION A2
January 9, 2025

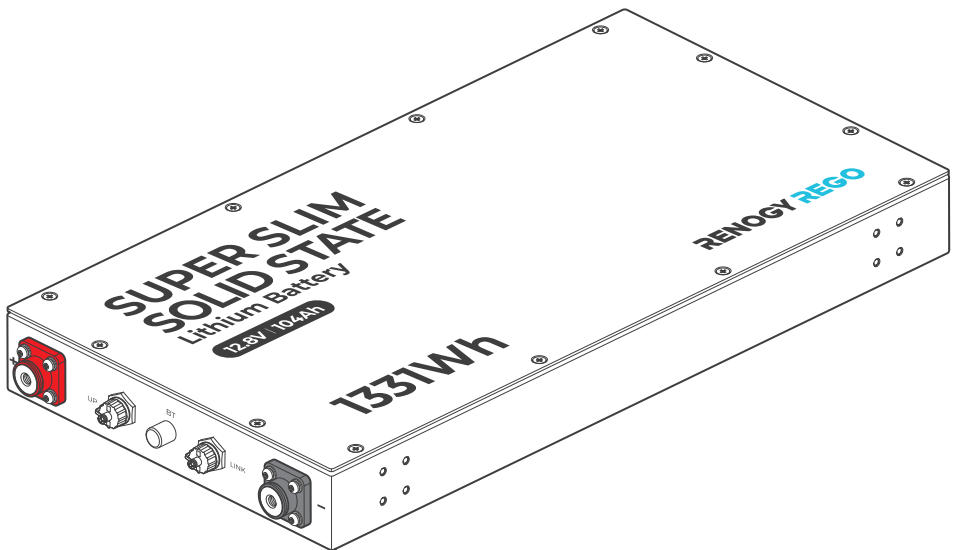

USER MANUAL

Before Getting Started

The user manual provides important operation and maintenance instructions for RENOGY REGO Series 12.8V 104Ah Super Slim Solid State Lithium Battery (hereinafter referred to as battery).

Read the user manual carefully before operation and save it for future reference. Failure to observe the instructions or precautions in the user manual can result in electrical shock, serious injury, or death, or can damage the battery, potentially rendering it inoperable.

- Renogy ensures the accuracy, sufficiency, and the applicability of information in the user manual at the time of printing due to continual product improvements that may occur.
- Renogy assumes no responsibility or liability for personal and property losses, whether directly and indirectly, caused by the user's failure to install and use the product in compliance with the user manual.
- Renogy is not responsible or liable for any failure, damage, or injury resulting from repair attempts by unqualified personnel, improper installation, or inappropriate operation.
- The illustrations in the user manual are for demonstration purposes only. Details may appear slightly different depending on product revision and market region.
- Renogy reserves the right to change the information in the user manual without notice. For the latest user manual, visit [renogy.com](https://www.renogy.com).

Disclaimer

RENOGY REGO Series 12.8V 104Ah Super Slim Solid State Lithium Battery User Manual © 2025 Renogy. All rights reserved.

RENOGY and **RENOGY** are registered trademarks of Renogy.

- All information in the user manual is subject to copyright and other intellectual property rights of Renogy and its licensors. The user manual may not be modified, reproduced, or copied, in whole or in part, without the prior written permissions of Renogy and its licensors.
- The registered trademarks in the user manual are the property of Renogy. The unauthorized use of the trademarks is strictly prohibited.

Online Manual

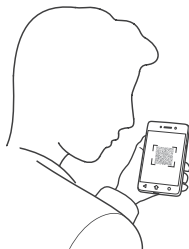

User Manual





Table of Contents

Symbols Used	1
Introduction	1
Key Features	1
SKU	2
What's In the Box?	2
Required Tools & Accessories	2
Get to Know Super Slim Solid State Lithium Battery	3
Dimensions	3
Secure the Battery	4
How to Size Battery Adapter Cables?	5
Step 1. Wear Insulating Gloves	5
Step 2. Check the Battery	5
Step 3. Plan a Mounting Site	6
Step 4. Install Battery Terminals	6
Step 5. Install the Insulation Sleeves	7
Step 6. Connect the Battery to Power Supply Devices	7
Step 7. CAN Communication Wiring (Optional)	8
Inter-Battery Communication	8
Communication with Renogy Power Supply and Monitoring Devices	9
How to Connect Batteries in Series or Parallel	13
Calculate Battery Voltage and Current in Series and Parallel Connections	13
Balance Batteries Prior to Connection	13
Series Connection vs. Parallel Connection	14
Battery Cell Balancing.....	15
Monitoring	15
Short-Range Monitoring via DC Home App	16
Wireless Long-Range Monitoring.....	16
Wired Long-Range Monitoring (Backbone Network)	17
Wired Long-Range Monitoring (Daisy Chain Network)	18
Charging/Discharging Parameter Settings	19
Battery Charging and Discharging Logic	19
Charging Logic.....	19
Discharging Logic	20

How to Estimate the Battery SOC?	20
Battery Management System	21
Troubleshooting	23
Specifications	24
General	24
Operation Parameters	24
Maintenance & Storage	25
Inspection	25
Cleaning	25
Checking Voltage	25
Storage	25
Important Safety Instructions	26
General	26
Battery Safety	26
Renogy Support	27
Battery Recycling	28

Symbols Used

The following symbols are used throughout the user manual to highlight important information.

-  **WARNING:** Indicates a potentially hazardous condition that could result in personal injury or death.
-  **CAUTION:** Indicates a critical procedure for safe and proper installation and operation.
-  **NOTE:** Indicates an important step or tip for optimal performance.

Introduction

The RENOGY REGO Series 12.8V 104Ah Super Slim Solid State Lithium Battery adopts a proprietary battery housing material in a smaller size for your RV application.

Weighing only half of the lead-acid counterparts, the battery can be safely discharged to 100% Depth of Discharge (DOD), delivering twice the energy. Manufactured with automotive grade battery cells, the battery features the highest safety standards and an extended 6000 cycle life. In addition, the smart Battery Management System (BMS) provides comprehensive protection to the battery.

Key Features

- **Unparalleled Performance**
Features a greater energy density, a deeper discharge capability, a higher round-trip efficiency, and a faster charging speed in a smaller size (61 mm thick) over counterparts in the market.
- **Uncompromising Quality**
Ensures an exceptional lifespan with up to 6000 cycles (80% DOD, 0.5C), a continuous charge current of 100A, a continuous discharge current of 200A, and a wide range of operating temperatures with the automotive grade battery cells.
- **Reliable Protection Mechanisms**
Designed with a sturdy internal structure for RV use, and includes more than 60 protections and alarms through the smart battery management system.
- **Real-time Monitoring Through DC Home App**
You can easily get the battery information through the DC Home app at any time.
- **Active Safety Protection with Self-Control Fuse**
Different from ordinary passive fuses, the self-control fuse can effectively prevent battery overcurrent and overvoltage failures.
- **Best-in-Class Capacity and Easy Expansion**
The battery provides a maximum capacity of more than 104Ah for a longer-lasting application. It supports up to 16 batteries in 4 series and 4 parallels system connection delivering a maximum of 48V (51.2V) 416Ah with 21.296 kWh.
- **Guaranteed System Safety**
The included semi-solid-state battery cells boast less organic solvents in electrolytes over liquid cells, making them less prone to leakage and combustion. Even at high temperatures, the electrolyte in semi-solid-state cells remains stable and is less likely to decompose, greatly reducing the risks of battery swelling, separator shrinkage, and thermal runaway.
- **More Reliable Charging at Low Temperatures**
The included semi-solid-state battery cells feature low solubility variation and low electrochemical impedance. Charging below 32°F (0°C) suppresses the formation of lithium dendrites, reducing the risk of short circuits and separator puncture. They support charging at 10A current from 14°F to 32°F (-10°C to 0°C).

SKU

RENOGY REGO Series 12.8V 104Ah
Super Slim Solid State Lithium Battery

RBT12104LFP-SSL-BT-G1

What's In the Box?

RENOGY REGO Series 12.8V 104Ah
Super Slim Solid State Lithium Battery × 1

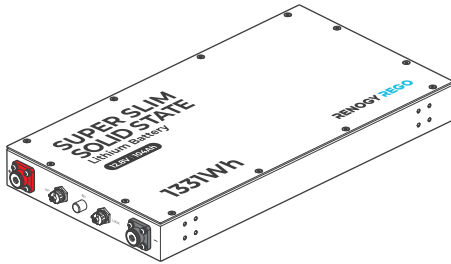

User Manual × 1

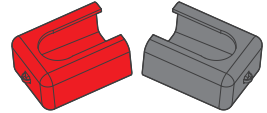

Insulation Sleeves × 2

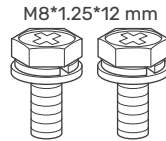

Terminal Bolts × 2

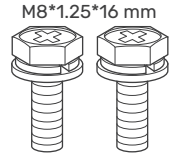

Long Terminal Bolts × 2



Make sure that all accessories are complete and free of any signs of damage.

Required Tools & Accessories

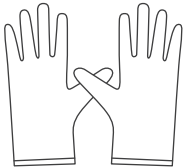

Insulating Gloves

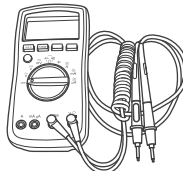

Multimeter

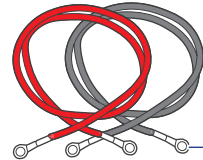

5/16 in (M8)
Battery Adapter Cables × 2

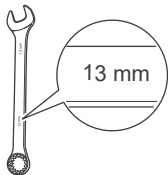

Wrench (17/32 in)



Phillips Screwdriver (#2)



Prior to installing and configuring the battery, prepare the recommended tools, components, and accessories.



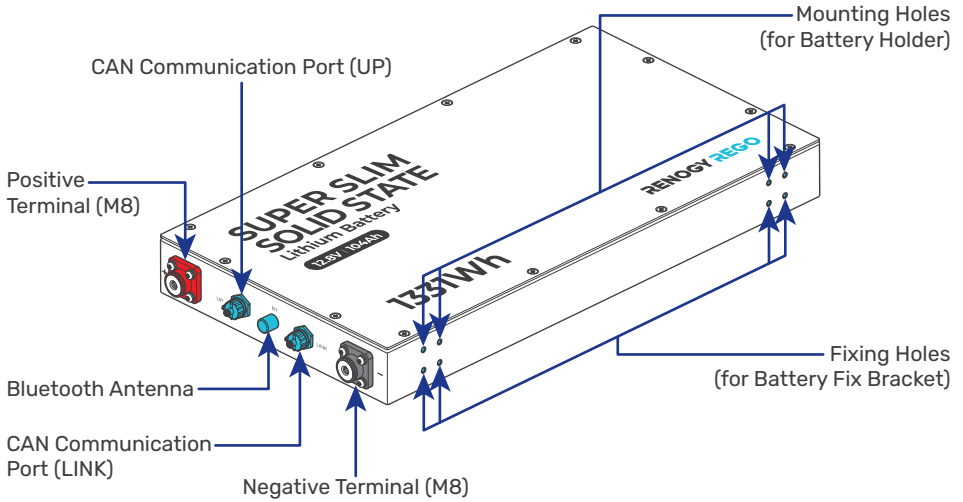

For how to size battery adapter cables, refer to "[How to Size Battery Adapter Cables?](#)" in this manual.

Get to Know Super Slim Solid State Lithium Battery

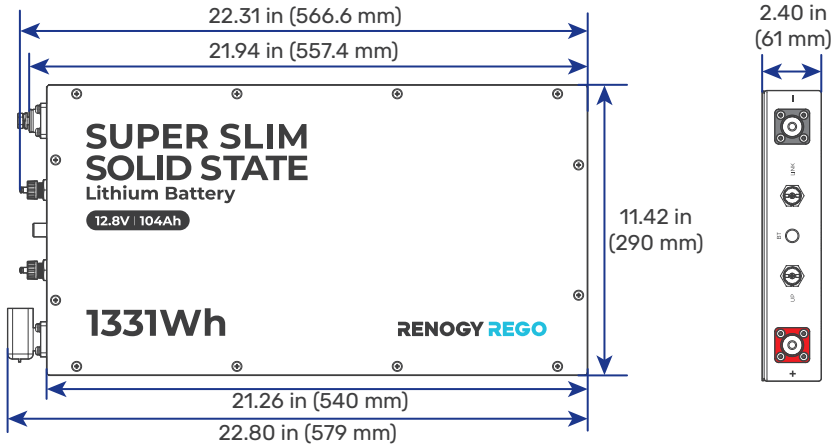

Dimensions



 **Weight** 28.22 lbs (12.8 kg)

 Dimension tolerance: ± 0.2 in (0.5 mm)

Secure the Battery

Securing the battery prevents damage to the battery from loose cables and bumps. You can purchase the following accessories and components on demand.

i You can secure the battery either on the floor or on a wall.

Recommended Accessories

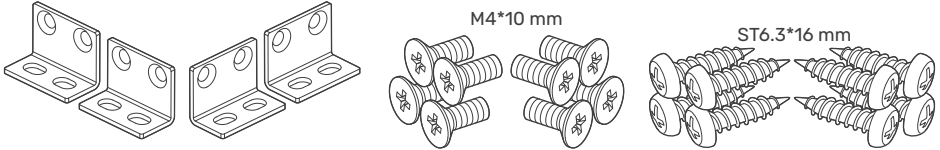

*Battery Fix Brackets Accessory Kit
(An accessory kit includes 4 battery fix brackets,
8 countersunk head screws, and 8 self-tapping screws.)

i Accessories marked with "*" are available on [renogy.com](https://www.renogy.com).

Step 1: Install the battery fix brackets through the fixing holes on the battery with the included countersunk head screws.

Left side

Right side

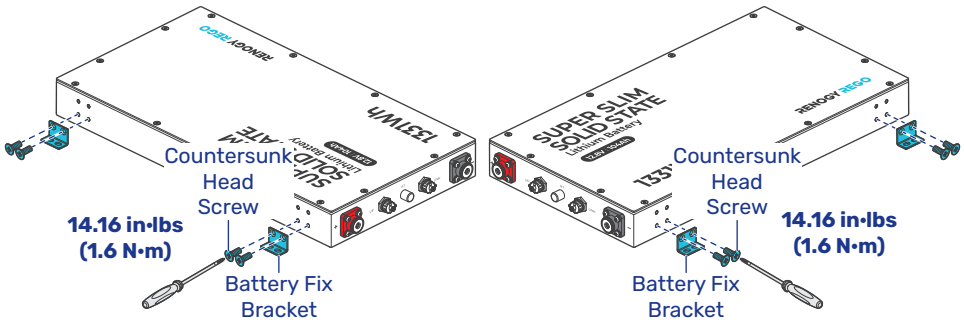

Step 2: Mount the battery on a flat surface with the included self-tapping screws.

Left side

Right side

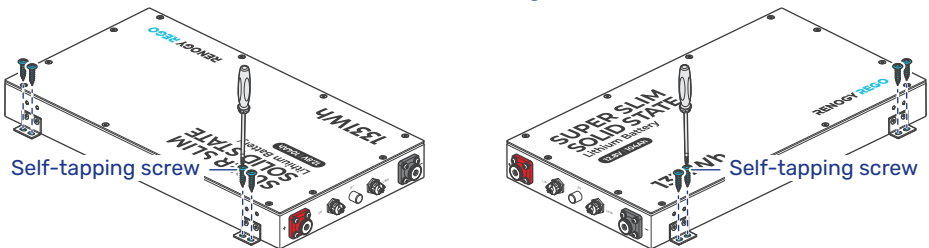

How to Size Battery Adapter Cables?

Use appropriately sized Battery Adapter Cables (sold separately) based on expected loads. Refer to the table below for copper cable ampacities with different gauge sizes for up to 13 feet (4 m) cables. Cables longer than 13 feet (4 m) may require thicker gauge wires to prevent excessive voltage drop in undersized wiring.

Cable Gauge Size	Ampacity	Cable Gauge Size	Ampacity
14 AWG (2.08 mm ²)	35A	2 AWG (33.6 mm ²)	190A
12 AWG (3.31 mm ²)	40A	1 AWG (42.4 mm ²)	220A
10 AWG (5.25 mm ²)	55A	1/0 AWG (53.5 mm ²)	260A
8 AWG (8.36 mm ²)	80A	2/0 AWG (67.4 mm ²)	300A
6 AWG (13.3 mm ²)	105A	4/0 AWG (107 mm ²)	405A
4 AWG (21.1 mm ²)	140A		

i The above values are from the NEC Table 310.17 for copper cables rated at 194°F (90°C), operating at an ambient temperature of no more than 86°F (30°C). Please note that wire gauge standards may vary due to factors such as temperature and installation conditions. In actual applications, it is recommended to refer to the latest NEC standards.

Step 1. Wear Insulating Gloves

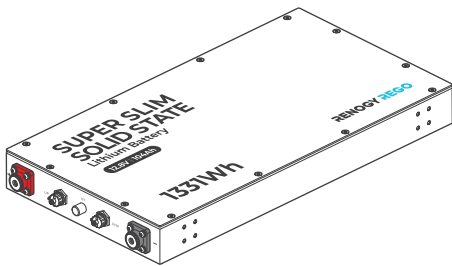

Insulating
Gloves

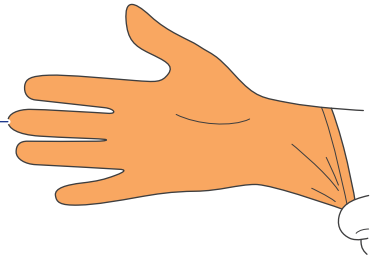

Step 2. Check the Battery

Inspect the battery for any visible damage including cracks, dents, deformation, and other visible abnormalities. All connector contacts shall be clean and dry, free of dirt or corrosion.

- ⚠** Do not touch the exposed electrolytes or powder if the battery is damaged.
- ⚠** If any uncovered electrolyte or powder comes into contact with your skin or eyes, flush the area immediately with plenty of clean water and seek medical attention.

Step 3. Plan a Mounting Site

For optimal battery performance, it is recommended to install the battery in a clean, cool, and dry location, free from any accumulation of water, oil, or dirt. Accumulation of such materials on the battery can lead to current leakage, self-discharge, and even short-circuiting.

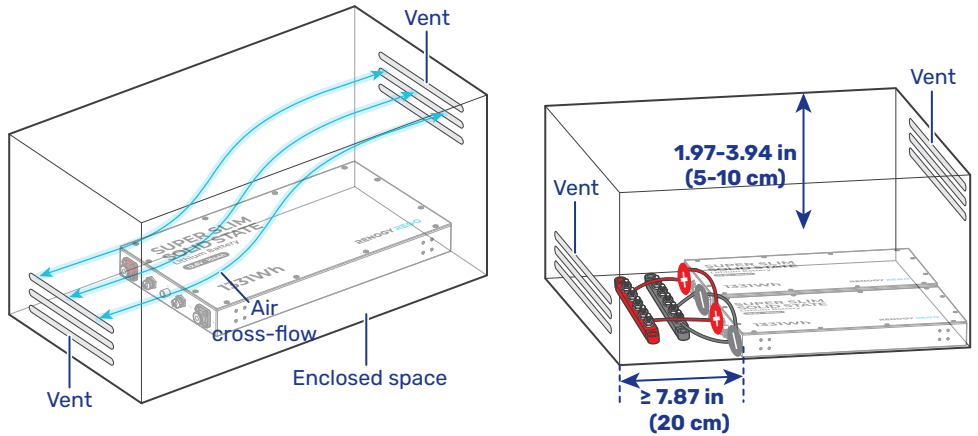

 Charge: 14°F to 131°F / -10°C to 55°C
Discharge: -4°F to 140°F / -20°C to 60°C

 5% to 95%







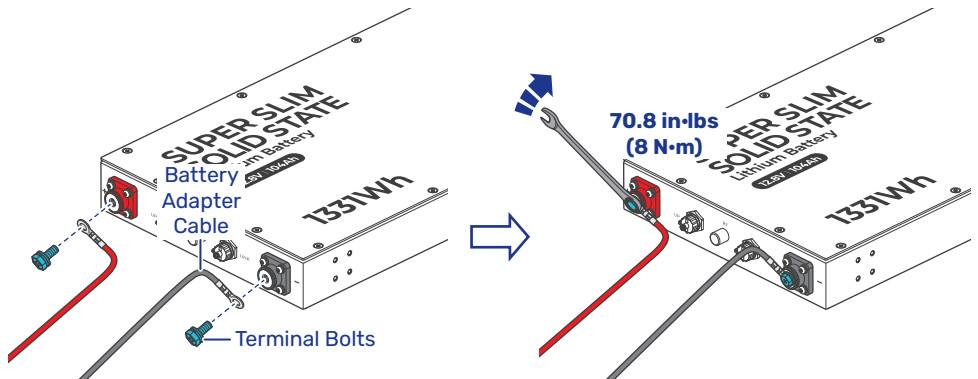

 Sufficient air flow must be provided to prevent excessive heat build-up and to minimize temperature variation between the connected batteries.

 This user manual takes a battery as an example to illustrate how to install the battery. Similar rules apply to scenarios involving multiple batteries.

Step 4. Install Battery Terminals

Install battery adapter cables on the battery via the included terminal bolts (M8*1.25*12 mm).



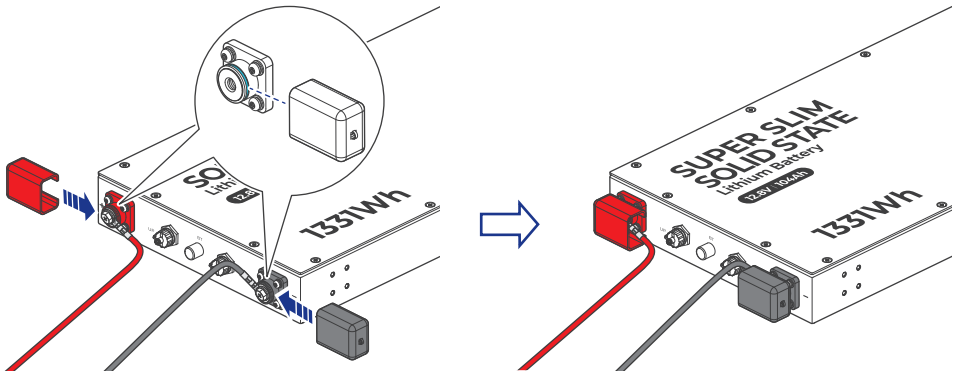

-  Ensure the cable lug and the top surface of the terminal are in contact, and place the washers on top of the lug. Do not place a washer between a battery terminal and a cable lug to avoid high resistance and excessive heating.
-  Avoid short-circuiting the battery terminals to prevent irreversible damage to the system and battery caused by current bursts.
-  Verify polarity before wiring to avoid irreversible battery damage due to polarity reversal.
-  Do not touch the positive and negative terminals of the battery with your hands.
-  To ensure safe and reliable operation of the system, please follow the manufacturer's recommended torque specifications when securing cable connections. Over-tightening can result in terminal breakage, while loose connections can lead to terminal meltdown or fire. When securing multiple cable lugs on a single battery terminal, use the included Long Terminal Bolts (M8 * 1.25 * 16 mm).

Step 5. Install the Insulation Sleeves



Step 6. Connect the Battery to Power Supply Devices

You can connect the battery to a distribution panel or power supply devices such as an inverter, a DC-DC battery charger, and a charge controller.

-  Please use circuit breakers, fuses, or disconnects appropriately sized by a certified electrician, licensed installers, or regional code authorities to protect all electrical equipment.
-  For details about series and parallel battery connections, refer to "[How to Connect Batteries in Series or Parallel](#)" in this manual.

For Batteries in Parallel or Series

For instructions on how to connect the solid batteries in series or parallel, contact Renogy technical support service at <https://www.renogy.com/contact-us>.

■ For a Single Battery

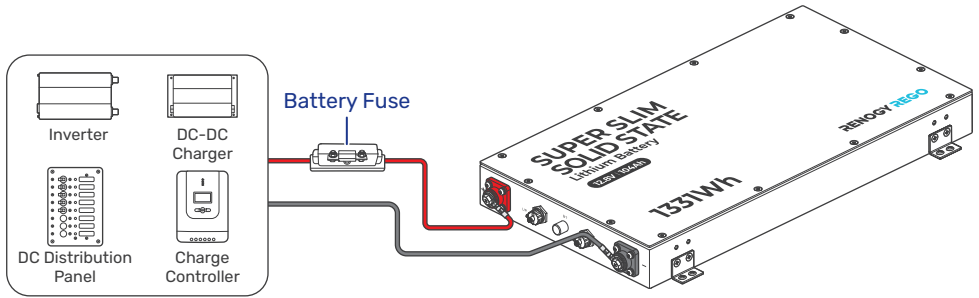

Step 7. CAN Communication Wiring (Optional)

REGO Series 12.8V 104Ah Super Slim Solid State Lithium Battery supports intra-battery communication and communication with Renogy monitoring and power supply devices supporting CAN. For either communication scenario, you need to pay attention to the following installation instructions of the CAN Communication Ports on the battery.

To properly connect or disconnect the 7-Pin CAN Communication Terminal Plug to or from the battery, you should

1. Remove the dust cover from the CAN Communication Port on the battery.
2. Ensure that the plug is oriented vertically toward the CAN Communication Port.
3. Rotate the terminal fixing nut to loosen or secure the plug.

Shaking the terminal plug while plugging or unplugging it is not allowed.

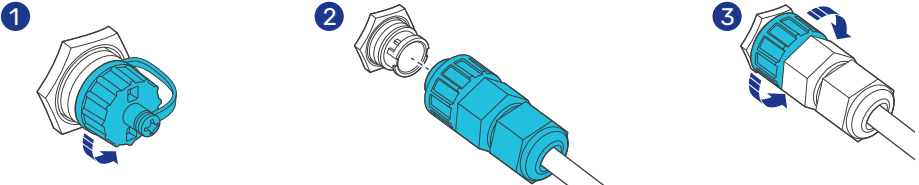

Inter-Battery Communication

REGO Series 12.8V 104Ah Super Slim Solid State Lithium Battery supports intra-battery communication and data exchange through the included CAN Communication Ports, which further enhances the efficiency and safety of the battery system.

Recommended Accessories

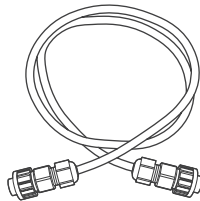

*7-Pin CAN Communication Cable(s)

 Accessories marked with “*” are available on [renogy.com](https://www.renogy.com).

For two batteries, connect the CAN Communication Port (UP) of the top battery to the CAN Communication Port (LINK) of the bottom battery using the 7-Pin CAN Communication Cable (not included).

The vacant CAN Communication Ports can be connected to other Renogy power supply devices supporting CAN communication as needed. For more details, refer to "[Communication with Renogy Power Supply and Monitoring Devices](#)".

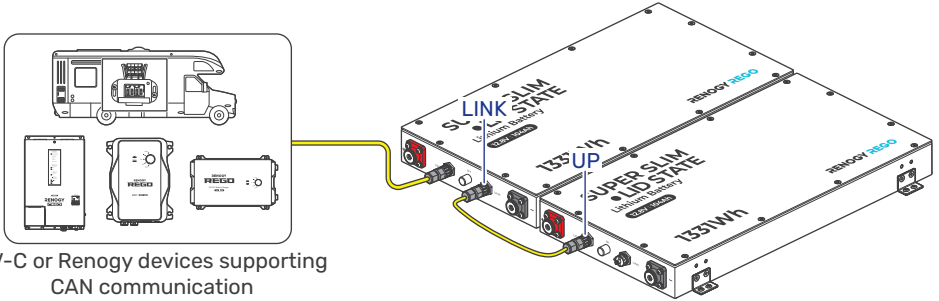

Communication with Renogy Power Supply and Monitoring Devices

The RENOGY REGO Series 12.8V 104Ah Super Slim Solid State Lithium Battery can communicate with other Renogy power supply devices supporting CAN communication and monitoring devices through CAN (common area network) bus, also known as RV-C, enabling safe operation, smart control, remote monitoring, and programmable settings.

You can connect the battery to other Renogy devices supporting CAN communication for real-time inter-device data communication through either of the CAN Communication Ports. 7-Pin CAN Communication Terminal Plugs and 7-Pin CAN Communication Terminal Plug adapter cables are required for the wiring.

The wiring details vary depending on the wiring schemes. This user manual elaborates on inter-device wiring in two schemes: backbone and daisy chain networks.

i For technical support from Renogy, please contact us through renogy.com/contact-us/.

■ Backbone Network

Ensure 120Ω terminating resistors are installed at both ends of the RV-C bus for successful communication with Renogy devices supporting CAN communication. If the RV user manual does not determine if the RV-C bus has a built-in 120Ω termination resistor, call the RV manufacturer to confirm.

i If the RV-C bus does not have a built-in 120Ω termination resistor, the battery will not communicate properly with other Renogy devices supporting CAN communication. Please use the Daisy Chain Network for communication connections.

Connect devices to the battery according to the wiring diagram provided by the RV manufacturer. Choose proper communication cables according to your specific demands.

Recommended Tools & Accessories

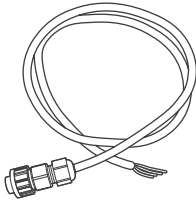

*7-Pin CAN Communication
Terminal Plug to Bare Drop Cable(s)

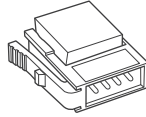

Drop Plugs

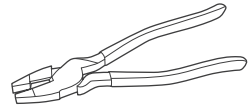

Split Joint Pliers

- i** Accessories marked with “**” are available on [renogy.com](https://www.renogy.com).
- i** The 7-Pin CAN Communication Terminal Plug to Bare Drop Cable is only for use with the battery. Please refer to the user manual of other devices for the communication cable types they require.
- i** The drop cable shall not exceed 19.6 feet (6 m), and the RV-C bus shall not exceed 98.4 feet (30 m).
- i** Choose the appropriate drop plugs that are compatible with the drop sockets used on the RV-C bus. Different RV manufacturers may use different types of drop sockets for inter-device communication connections. If you are unsure about the correct drop plug selection, consult with the RV manufacturer. In this manual, the Mini-Clamp II plug (4-pin) is used as an example.
- i** Different Drop Plugs follow different pinouts. Crimp the Drop Plugs on the Drop Cables following the correct pinout. If you are not sure about the Drop Plug pinout, check with the RV manufacturer.

- Step 1:** Install the Drop Plugs on the bare end of the 7-Pin CAN Communication Terminal Plug to Bare Drop Cable. The white CAN_H wire goes to pin 2, the blue CAN_L wire goes to pin 3, and the yellow GND wire goes to pin 4. Leave pin 1 empty.
- Step 2:** Squeeze the crimp areas of the Drop Plugs with the Split Joint Pliers.
- Step 3:** Locate the drop tap (not included) on the RV-C bus that is the closest to the installation site of the battery. The drop taps are usually located above the entry door, in the bathroom, or under the bed in the RV.
- Step 4:** Connect the Drop Plugs on the drop cables and other Renogy devices supporting CAN communication to the drop sockets on the drop tap.
- Step 5:** Insert the 7-Pin CAN Communication Terminal Plug into any of the CAN Communication Port (UP) of the battery.

- i** If you fail to locate the drop taps, please contact the RV manufacturer for help.
- i** Different drop taps are used on the RV-C bus by different RV manufacturers. This user manual takes the 4-socket drop tap as an example.

STEP-1 Install Cables on the RV-C bus

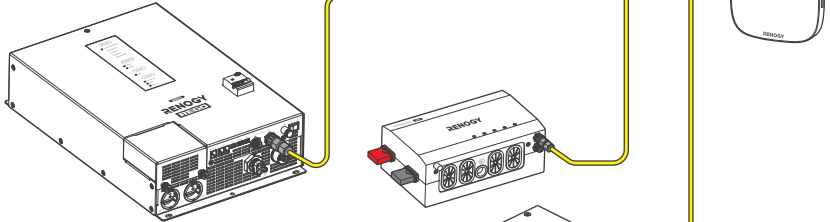
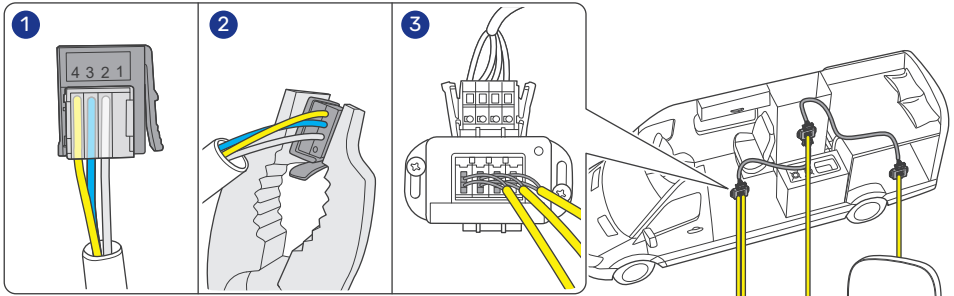

STEP-2 Install Cable on the Battery

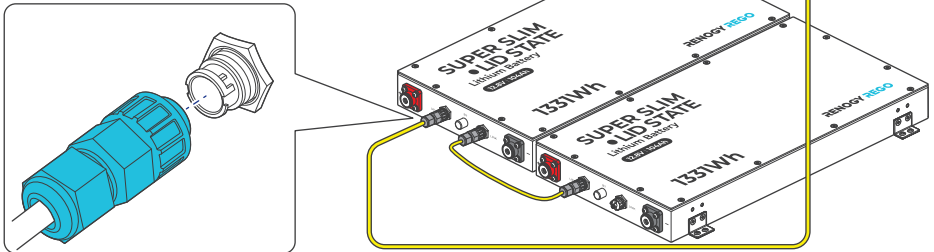

Daisy Chain Network

The daisy chain network applies to RVs that are not integrated with RV-C buses.

Please select the appropriate adapter cable based on the type of the CAN Communication Port specific to the device. For example:

- Battery to Renogy Combiner Box: 7-Pin CAN Communication Cable
- Battery to Renogy ONE Core: 7-Pin CAN Communication Terminal Plug to RJ45 Port Adapter Cable and RJ45 Ethernet Cable (CAT5 or above)
- Battery to REGO DC-DC Battery Charger: 7-Pin CAN Communication Terminal Plug to RJ45 Port Adapter Cable and LP16 Plug (7-Pin) to RJ45 Communication Cable

i This section is based on a 7-Pin CAN Communication Cable.

Recommended Accessories

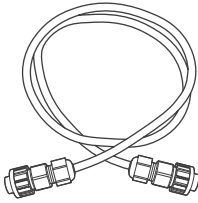

*7-Pin CAN Communication Cable(s)

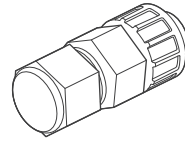

*7-Pin CAN Communication Terminal Plug(s)

- Accessories marked with "*" are available on [renogy.com](https://www.renogy.com).
- The communication cable should be less than 19.6 feet (6 m).
- Choose proper terminal plugs based on the specific CAN ports.

The quantity of communication cables and plugs varies based on the position of the battery in the daisy chain network. When the battery is positioned at either the first or the last device in the daisy chain network, one 7-Pin CAN Communication Terminal Plug and one communication cable are required. In scenarios where the battery is located in the middle of the daisy chain network, two communication cables are needed.

Step 1: Connect devices in series with the battery through either of the CAN Communication Ports with the Communication Cable(s) (sold separately).

Step 2: Plug the Terminator Plugs (sold separately) into the vacant CAN Communication Ports on the first and last devices.

Battery is Positioned at the First or Last in the Daisy Chain Network

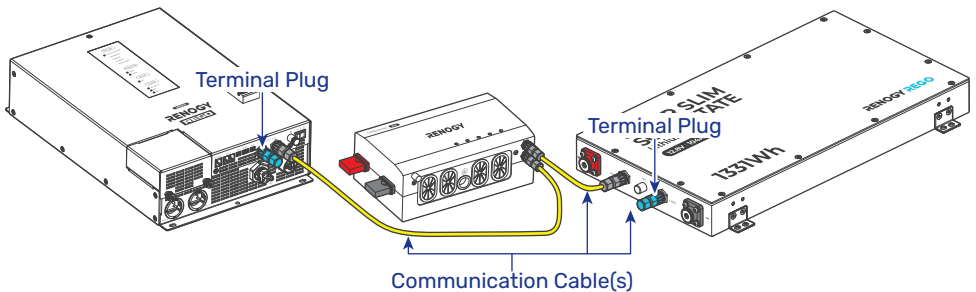

Battery is in the Middle of the Daisy Chain Network

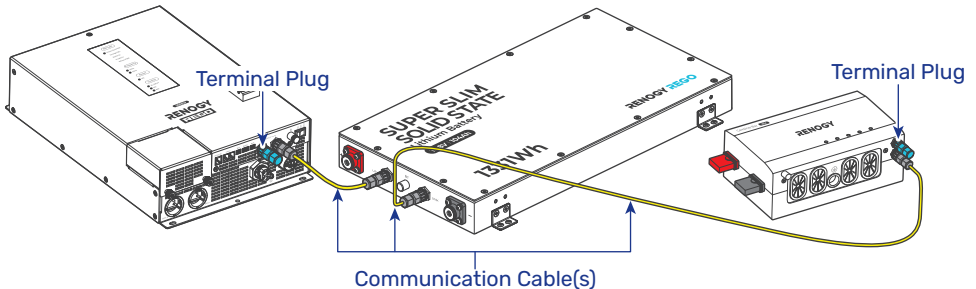

How to Connect Batteries in Series or Parallel

Calculate Battery Voltage and Current in Series and Parallel Connections

The cables between each connected battery should be of equal length to ensure that all batteries can work equally together. You can connect up to 4 batteries in parallel or 4 batteries in series.

Parallel Connection





System Voltage	System current
12.8V	Sum of the individual battery currents

Series Connection



System Voltage	System current
Sum of the individual battery voltages	104A

-  Long terminal bolts (M8 * 1.25 * 16 mm) should be used to secure the battery adapter cables. The recommended torque is 70.8 in-lbs (8 N·m).
-  Do not connect batteries with different chemistries, rated capacities, nominal voltages, brands, or models in parallel or in series. This can result in potential damage to the batteries and the connected devices, and can also pose safety risks.
-  Avoid connecting batteries that have been purchased for more than half a year. Over time, batteries can degrade and their performance may decrease, which can affect their ability to deliver reliable power and may lead to safety hazards.

Balance Batteries Prior to Connection

Before connecting batteries in series or parallel, it is important to balance them to reduce voltage differences and optimize their performance. Follow these three steps:

Step 1: Charge each battery individually to its full capacity using a suitable charger.

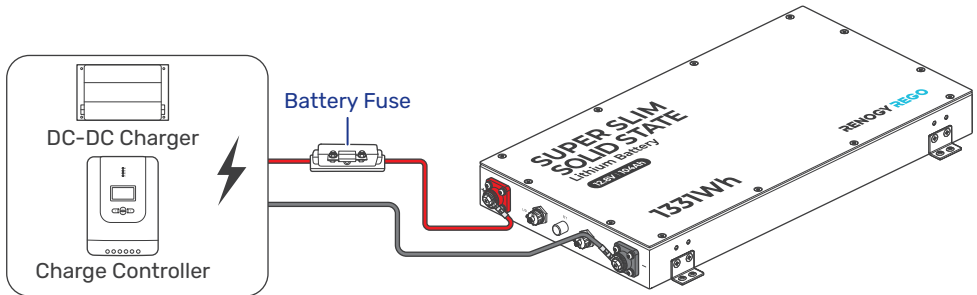

Step 2: Use a voltmeter to measure the voltage of each battery. It is best to keep the voltage difference of each battery less than 0.1V.

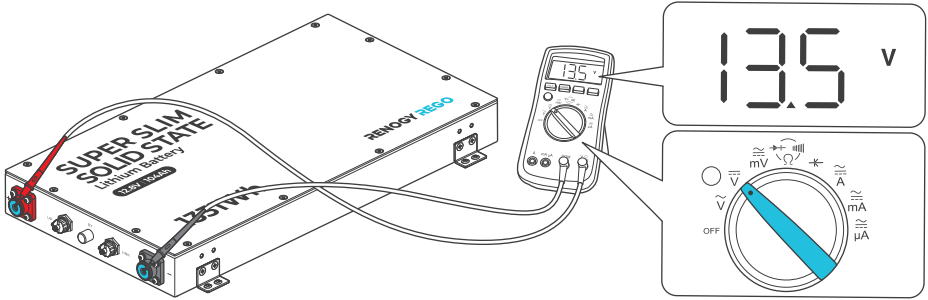

Step 3: Connect all the batteries in parallel and allow them to rest together for 12 to 24 hours before use.

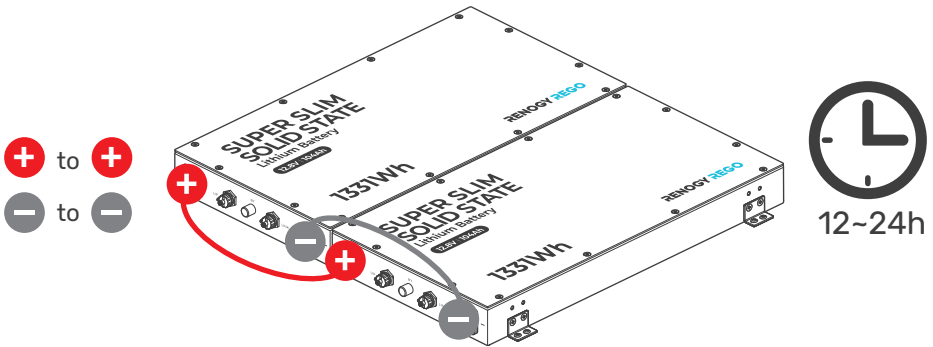

i It is recommended to periodically rebalance the battery voltages every six months when connecting multiple batteries as a battery system. Slight voltage differences can occur among batteries over time due to factors like battery chemistry, capacity, temperature, and usage patterns.

Series Connection vs. Parallel Connection

Parallel Connection

2P	Battery System	12V (12.8V) 208Ah
	Energy	2662Wh
16P (Max)	Battery System	12V (12.8V) 1664Ah
	Energy	21296Wh

Series Connection

2S	Battery System	24V (25.6V) 104Ah
	Energy	2662Wh
4S (Max)	Battery System	48V (51.2V) 104Ah
	Energy	5324Wh

Parallel & Series Connection

2P2S	Battery System	24V (25.6V) 208Ah
	Energy	5324Wh
2P4S	Battery System	48V (51.2V) 208Ah
	Energy	10648Wh
4P2S	Battery System	24V (25.6V) 416Ah
	Energy	10648Wh
4P4S (Max)	Battery System	48V (51.2V) 416Ah
	Energy	21296Wh



Battery Cell Balancing

The battery employs bypass circuit to maintain the balance between each battery cell group. Each battery cell group is connected with a bypass resistor and a switch in parallel. During the charging process, if the highest-voltage battery cell group reaches the set balancing starting voltage and the voltage difference between the highest-voltage and the lowest-voltage battery cell group exceeds the set voltage difference, the switch connected to the highest-voltage battery cell group will be closed to shunt the charge current around the highest-voltage battery cell group through the bypass resistor until the voltage difference drops below the set value. To avoid excessive energy loss, the battery cell balancing is only performed during the charging process.

Monitoring

Depending on the specific application, the battery can establish either short-range or long-range communication connections with monitoring devices. These monitoring devices facilitate real-time monitoring, programming, and complete system management, offering comprehensive control and enhanced flexibility.

You can monitor the performance of the battery through either or both of the following methods: DC Home app (free of charge) Renogy ONE Core (sold separately).

-  Ensure the Bluetooth of your phone is turned on.
-  The version of the DC Home app might have been updated. Illustrations in the user manual are for reference only. Follow the instructions based on the current app version.
-  To ensure optimal system performance, keep the phone within 10 feet (3 m) of the battery.

To ensure the optimal device compatibility, download and log into the latest DC Home app.

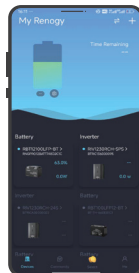

DC Home App



Short-Range Monitoring via DC Home App

Pair the battery with the DC Home app. Monitor the battery parameters via the app.

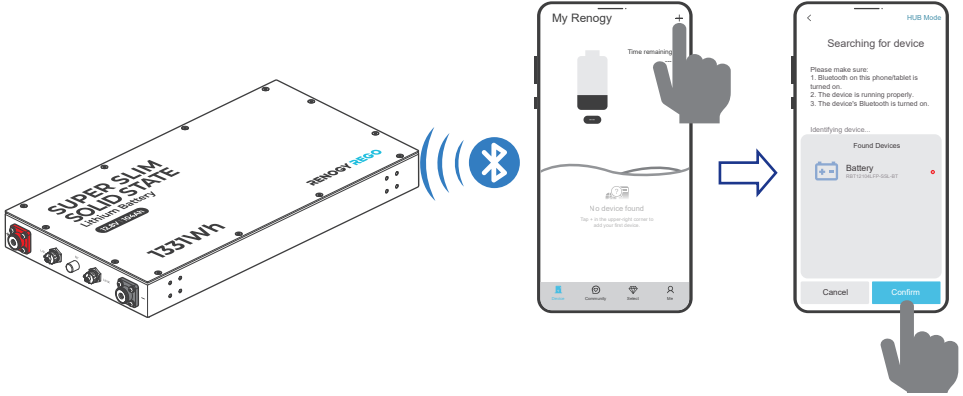

Wireless Long-Range Monitoring

If long-range communication and programming are required, connect the battery to Renogy ONE Core (sold separately) through Bluetooth, and then pair Renogy ONE Core with the DC Home app.

Recommended Components



*RENOGY ONE Core

- Components marked with "*" are available on [renogy.com](https://www.renogy.com).
- Ensure that the Renogy ONE Core is powered on before the connection.
- For instructions on Renogy ONE Core, see [Renogy ONE Core User Manual](#).
- Ensure the battery does not communicate with any other device.

Step 1: Connect the battery to Renogy ONE Core through the Bluetooth of your phone.

Step 2: Pair the Renogy ONE Core with the DC Home app through Wi-Fi or by scanning the QR code in Renogy ONE Core. On Renogy ONE Core, go to "System > Settings > Pair with App" to get the QR code. For pairing instructions on Renogy ONE Core, see [Renogy ONE Core User Manual](#).

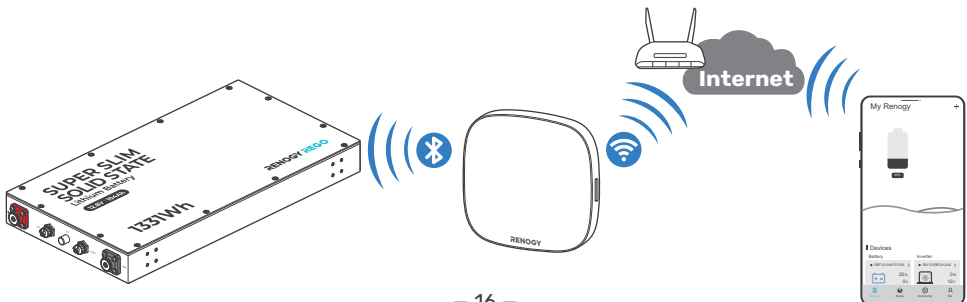

Wired Long-Range Monitoring (Backbone Network)

If long-range communication and programming are required, connect the battery to Renogy ONE Core through wires, and then pair Renogy ONE Core with the DC Home app.

Recommended Components & Accessories



*Renogy ONE Core

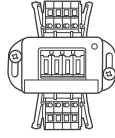

Common Drop Tap

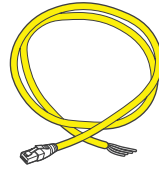

Communication Cable
(RJ45 Plug to Bare Drop Cable)

- Components marked with "*" are available on [renogy.com](https://www.renogy.com).
- Ensure that the Renogy ONE Core is powered on before the connection.
- For instructions on Renogy ONE Core, see [Renogy ONE Core User Manual](#).
- Ensure the battery does not communicate with any other device.
- Select the appropriate communication cable (sold separately) according to the distance between devices. The communication cable should be less than 19.6 feet (6 m).
- Different terminal block plugs are used on different Common Drop Taps and follow different pinouts. If you are unsure about the pinout of the terminal block plug, contact the RV manufacturer.

Step 1: Replace the terminated drop tap at either end of the RV-C bus with the Common Drop Tap (not included). Secure the bare wires of the Drop Cable (not included) onto the terminal block plug of the Common Drop Tap following the terminal block plug pinout. Plug the Drop Cable to the RJ45 port of Renogy ONE Core. For wiring instructions on Renogy ONE Core, see [Renogy ONE Core User Manual](#).

Step 2: Monitor and program the complete system on Renogy ONE Core or the DC Home app.

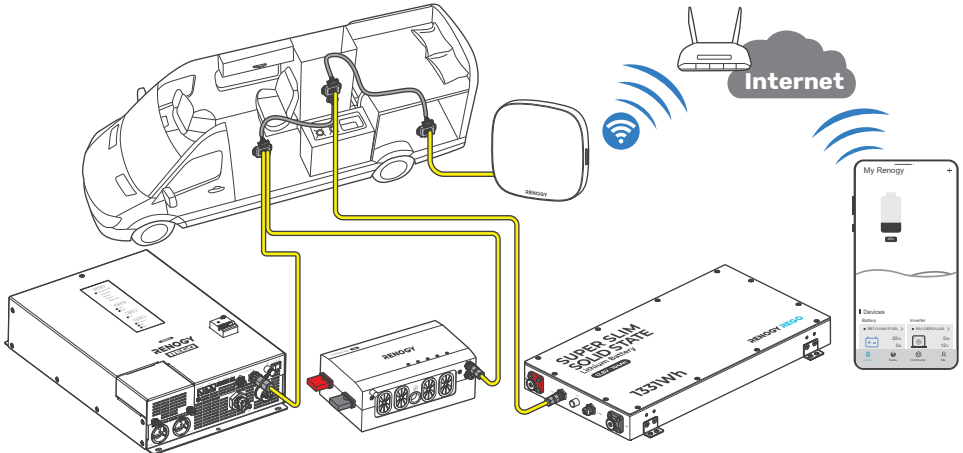

Wired Long-Range Monitoring (Daisy Chain Network)

If long-range communication and programming are required, connect the battery to Renogy ONE Core through wires, and the Renogy ONE Core to the DC Home app through Wi-Fi.

Recommended Components & Accessories



*Renogy ONE Core

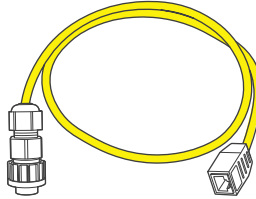

*7-Pin CAN Communication Terminal Plug to RJ45 Port Adapter Cable

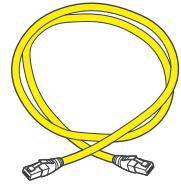

RJ45 Ethernet Cable (CAT5 or above)

- i** Components and accessories marked with "*" are available on [renogy.com](https://www.renogy.com).
- i** Ensure that the Renogy ONE Core is powered on before the connection.
- i** For instructions on Renogy ONE Core, see [Renogy ONE Core User Manual](#).
- i** Ensure the battery does not communicate with any other device.
- i** Select the appropriate communication cable (sold separately) according to the distance between devices. The communication cable should be less than 19.6 feet (6 m).

Step 1: Remove the Terminator Plug from the Renogy device at either end of the daisy chain.

Step 2: Connect the Renogy ONE Core to the free CAN Communication Port on the Renogy device with the Communication Adapter Cable (sold separately) and RJ45 Ethernet Cable. For wiring instructions on Renogy ONE Core, see [Renogy ONE Core User Manual](#).

Step 3: Pair Renogy ONE Core with the DC Home app. Monitor and program the complete system on the Renogy ONE Core or the DC Home app.

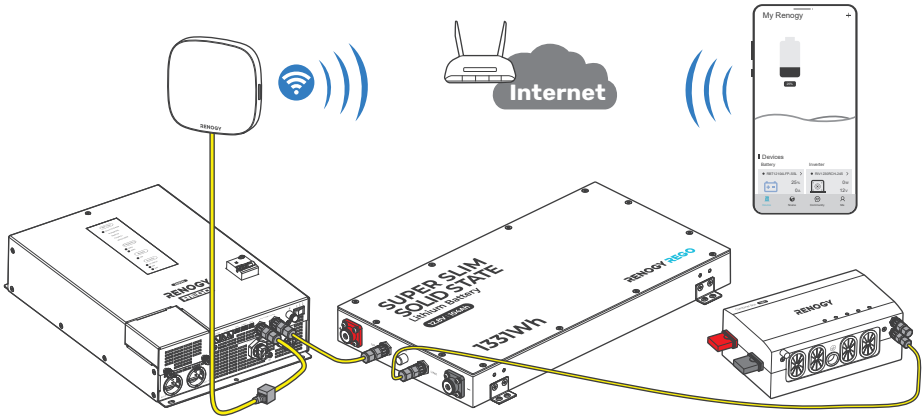

Charging/Discharging Parameter Settings

It is recommended that a single 12.8V 104Ah battery should be charged at 50A with a maximum allowable charging current at 100A. For single-battery scenarios, we recommend using 12V charge controllers rated at least 50A. For added safety and flexibility, a 12V 100A charge controller or battery charger is an ideal choice. For scenarios containing multiple batteries connected in series or parallel, consider the total voltage and capacity.

Charge (for Charge Controller & Battery Charger)

Boost Voltage	14.4V	Overvoltage Disconnect	15.0V
Bulk/Absorption Voltage	14.4V / Disabled	Overvoltage Reconnect	14.2V
Boost Return Voltage	13.2V		

Discharge (for Inverter)

Low Voltage Reconnect	12.6V	Undervoltage Warning	12.0V
Undervoltage Shutdown	10.0V		

i The parameters in the table are applicable to 12V (12.8V) battery packs. For 24V (25.6V) packs, multiply the values by 2, and for 48V (51.2V) packs, multiply by 4.

Battery Charging and Discharging Logic

The battery may be received at a partial state of charge (SOC) depending on the time between manufacturing and shipping. It is crucial to fully charge the battery before its initial use. In case the battery shuts off due to low SOC, promptly disconnect it from loads and charge it to prevent irreversible damage. Follow the instructions in this user manual for proper charging and usage to ensure optimal battery performance and longevity.

Charging Logic

The standard charging process for the battery involves charging at a constant current of 50A until the battery voltage reaches 14.4V, followed by charging at a constant voltage of 14.4V while tapering the charge current. The charging process is considered complete when the charge current is less than 5A (also known as tail current).

The standard charging process typically takes 2.5 hours and requires battery temperatures to be between 32°F and 131°F (0°C and 55°C) for safe charging. Leaving the battery on float will continue to balance the battery cells without damaging the battery.

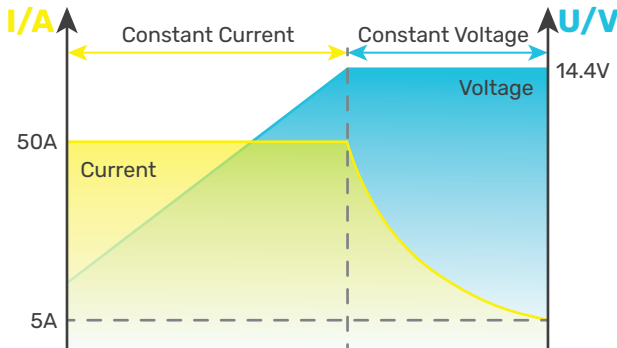

i Lithium batteries are compatible with various charging methods, including MPPT charge controller, AC charger, and DC-DC charger. The crucial parameter setting for these chargers is to set the charge voltage, boost voltage, or bulk voltage at 14.4V ($\pm 0.2V$).

⚠ Do not overcharge or overdischarge the battery.

⚠ Do not discharge the battery at high temperatures above 140°F (60°C).

⚠ Only charge the battery with a battery charger or charge controller that is compatible with lithium iron phosphate batteries.

⚠ Do not exceed the maximum continuous charge current (100A) of the battery.

Discharging Logic

During standard discharging, the battery is discharged at a constant current of 100A until the voltage drops to 10V. To ensure safe discharging, the battery temperature should be between -4°F (-20°C) and 143.6°F (62°C).

i To ensure safe and optimal battery usage, it is recommended to pair the battery with a discharge device that features a low voltage disconnect (LVD) function.

⚠ Do not connect large loads to the battery when it is running low.

⚠ Do not exceed the maximum continuous discharge current (200A) of the battery.

How to Estimate the Battery SOC?

The SOC values listed below are estimated based on the resting voltage (open-circuit voltage at rest) when the battery is at rest for 30 minutes, not in charging or discharging state.

SOC	Open Circuit Voltage	SOC	Open Circuit Voltage
100%	13.6V	30%	12.9V
99%	13.4V	20%	12.8V
90%	13.2V	14%	12.7V
70%	13.1V	9%	12.6V
40%	13.0V	0%	10.0V

i The table above is for reference only because slight variations in battery voltage may occur among different batteries.

Battery Management System

This smart battery management system has more than 60 fault alarms and protections to fully protect your battery safety. Below we list some common faults and protections for reference.

Battery Operating Status		Condition (For Reference Only)	
Battery Cell Overvoltage	Protection	Trigger	Battery Cell Voltage $\geq 3.65V$
		Recover	Battery Cell Voltage $\leq 3.45V$
Battery Cell Undervoltage	Protection	Trigger	Battery Cell Voltage $\leq 2.7V$ ($> 0^{\circ}C$) Battery Cell Voltage $\leq 2.2V$ ($\leq 0^{\circ}C$)
		Recover	Battery Cell Voltage $\geq 3.1V$ ($> 0^{\circ}C$) Battery Cell Voltage $\geq 3.0V$ ($\leq 0^{\circ}C$)
Cell Undervoltage Permanent Failure	Protection	Trigger	Battery Cell Voltage $\leq 1.5V$
Charge High Temperature	Protection	Trigger	Battery Temperature $\geq 131^{\circ}F$ ($55^{\circ}C$)
		Recover	Battery Temperature $\leq 122^{\circ}F$ ($50^{\circ}C$)
Discharge High Temperature	Protection	Trigger	Battery Temperature $\geq 143.6^{\circ}F$ ($62^{\circ}C$)
		Recover	Battery Temperature $\leq 122^{\circ}F$ ($50^{\circ}C$)
Nominal Charge Low Temperature	Protection	Trigger	Battery Temperature $\leq 32^{\circ}F$ ($0^{\circ}C$) Charging at 0.1C is allowed.
		Recover	Battery Temperature $\geq 37^{\circ}F$ ($3^{\circ}C$)
Small-Current Charge Low Temperature	Protection	Trigger	Battery temperature $< 14^{\circ}F$ ($-10^{\circ}C$)
		Recover	Battery temperature $> 19.4^{\circ}F$ ($-7^{\circ}C$)
Discharge Low Temperature	Protection	Trigger	Battery Temperature $\leq -4^{\circ}F$ ($-20^{\circ}C$)
		Recover	Battery Temperature $\geq 1.4^{\circ}F$ ($-17^{\circ}C$)
Charge Overcurrent	Primary Protection	Trigger	Charge Current $\geq 115A$ (15s)
		Recover	Discharge Current $\geq 0.5A$ or Recover automatically after 60s
	Secondary Protection	Trigger	Charge Current $\geq 118A$ (5s)
		Recover	Discharge Current $\geq 0.5A$ or Recover automatically after 60s
	Ultimate protection	Trigger	Charge Current $\geq 200A$ (300ms)
		Recover	Discharge Current $\geq 0.5A$ or Recover automatically after 60s Charging is locked when the Ultimate Protection is triggered three times.

Battery Operating Status		Condition (For Reference Only)	
Discharge Overcurrent	Primary Protection	Trigger	Discharge Current $\geq 215A$ (60s)
		Recover	Charge Current $\geq 0.5A$ or Recover automatically after 60s
	Secondary Protection	Trigger	Discharge Current $\geq 260A$ (30s)
		Recover	Charge Current $\geq 0.5A$ or Recover automatically after 60s
	Ultimate protection	Trigger	Discharge Current $\geq 300A$ (200ms)
		Recover	Charge Current $\geq 0.5A$ or Recover automatically after 10s Discharging is locked when the Ultimate Protection is triggered three times.
Short Circuit	Protection	Trigger	Discharge Current $\geq 1000A$ Discharging is shut down for 10s when Short Circuit Protection is triggered. For the threeth time in a row that Short Circuit Protection is triggered, discharging is locked.
		Recover	Charge Current $\geq 0.5A$ and discharging is unlocked.

Troubleshooting

Problem	Possible Causes	Solution
<ul style="list-style-type: none"> The battery is unable to be activated with a charge/discharge current greater than 1A The battery is activated at open circuit voltage below 10V 	Severe battery overdischarge due to self-discharge or parasitic loads	Revive the battery with a battery charger or charge controller featuring lithium battery activation or force charging.
The battery shuts off due to undervoltage protection.	The battery voltage drops below the preset threshold	Disconnect the battery from loads, and charge the battery with a current greater than 1A as soon as possible.
The battery cuts off the charging current due to overvoltage protection	The battery voltage exceeds the preset threshold during charging.	<ol style="list-style-type: none"> 1. Disconnect the battery from the charging source. 2. Reduce charge voltage by 0.2V to 0.4V for 6 hours. 3. Attempt to fully charge the battery again with the correct voltage setting. If the problem persists with a lithium iron phosphate compatible charging source and correct voltage setting, repeat the above steps.
The battery temperature gets too high/low during operation and triggers high/low temperature protection	The battery temperature exceeds the preset threshold.	<ol style="list-style-type: none"> 1. Disconnect the battery from the charging source or loads. 2. Cool down/Warm up the battery. 3. The battery recovers from high/low temperature protection automatically and continues operating.
Short circuit protection is triggered.	Short circuit occurs in the battery.	<ol style="list-style-type: none"> 1. Remove the short circuit as soon as possible 2. Charge the battery with a current greater than 1A.
Charge/Discharge over-current protection is triggered due to too high current passing through the battery.	Excessive current flows through the battery during charging or discharging.	Disconnect the battery from the charging source or loads as soon as possible.

 For further assistance, contact Renogy technical support service at <https://www.renogy.com/contact-us>.

Specifications

General

Battery Cell Type	Lithium Iron Phosphate
Rated Capacity (0.5C, 25°C)	104Ah
Nominal Voltage	12.8V
Voltage Range	10V to 14.8V
Cycle Life (0.5C, 25°C)	6000 Cycles (80% DOD)
Dimension	22.8 x 11.4 x 2.4 in / 579 x 290 x 61 mm
Weight	28.22 lbs / 12.8 kg
Connection Method	4S4P
Terminal Bolt Size	Terminal Bolt: M8 x 1.25 x 12 mm Long Terminal Bolt: M8 x 1.25 x 16 mm
Recommended Terminal Torque	70.8 in-lb / 8 N·m
Protection Rating	IP67
Certification	MSDS, UN38.3, FCC, CE, PSE, RoHS, RCM, IC, and UKCA

Operation Parameters

Charge Voltage	14.4V
Maximum Continuous Charge Current	100A
Maximum Continuous Discharge Current	200A
Peak Discharge Current	290A@30S
Charge Temperature Range	14°F to 131°F / -10°C to 55°C (14°F to 32°F / -10°C to 0°C, 0.1C)
Discharge Temperature Range	-4°F to 140°F / -20°C to 60°C
Storage Temperature Range	-4°F to 140°F / -20°C to 60°C
Operation Relative Humidity	5% to 95%

Maintenance & Storage

Inspection

Please perform regular inspections following the steps below:

- Examine the external appearance of the battery. The housing and terminals of the battery shall be clean, dry, and free of corrosion.
- Check battery cables and connections. Replace any damaged cables and tighten any loose connections.

i In certain application scenarios, corrosion may occur around the terminals. Corrosion can cause increased resistance and poor contact. It is recommended to regularly apply insulation grease to each terminal. Insulation grease can form a moisture-resistant seal and protect the terminals from corrosion.

Cleaning

Please clean the battery at regular intervals following the steps below:

- Disconnect the battery from the system.
- Clear the leaves and debris from the battery.
- Clean the battery with a soft, lint-free cloth. The cloth can be dampened with water or mild soap and water if the battery is extremely dirty.
- Dry the battery with a soft, lint-free cloth.
- Keep the area around the battery clean.
- Reconnect the battery to the system.

Checking Voltage

Please check the battery voltage periodically to assess battery health. If the battery is unable to be activated with a charge/discharge current greater than 1A or the battery is activated with an open circuit voltage below 10V, the battery may have been severely overdischarged due to self-discharge or parasitic loads. Please stop using the battery until the fault can be corrected and the battery can be charged.

Storage

Please follow the steps below to ensure that the battery emerges from storage in a good condition:

- Charge the battery to 30% to 50% SOC.
- Disconnect the battery from the system.
- Store the battery in a well-ventilated, dry, clean area with temperatures between -4°F (-20°C) and 140°F (60°C).
- Do not expose the battery to direct sunlight, moisture, or precipitation.
- Handle the battery carefully to avoid sharp impacts or extreme pressure on the battery housing.
- Charge the battery at least once every 3 to 6 months to prevent it from overdischarge.
- Fully charge the battery when it is taken out of storage.

i Please follow the steps above to store the battery. Otherwise, the warranty will be void.

Important Safety Instructions

Renogy accepts no liability for any damage caused by:

- Force majeure including fire, typhoon, flood, earthquake, war, and terrorism.
- Intentional or accidental misuse, abuse, neglect or improper maintenance, and use under abnormal conditions.
- Improper installation, improper operation, and malfunction of a peripheral device.
- Contamination with hazardous substances or radiation.
- Alterations to the product without express written consent from the manufacturer.

General

- Wear proper protective equipment and use insulated tools during installation and operation. Do not wear jewelry or other metal objects when working on or around the battery.
- Keep the battery out of the reach of children.
- Do not dispose of the battery as household waste. Comply with local, state, and federal laws and regulations and use recycling channels as required.
- In case of fire, put out the fire with a FM-200 or CO₂ fire extinguisher.
- Do not expose the battery to flammable or harsh chemicals or vapors.
- Clean the battery regularly.
- It is recommended that all cables should not exceed 10 meters because excessively long cables result in a voltage drop.
- The cable specifications listed in the quick guide account for critical, less than 3% voltage drop and may not account for all configurations.
- Do not expose the battery to strong electrostatic fields, strong magnetic fields, or radiation.

Battery Safety

- Please keep the battery away from water, heat sources, sparks, and hazardous chemicals.
- Do not puncture, drop, crush, burn, penetrate, shake, strike, or step on the battery.
- Do not open, dismantle, repair, tamper with, or modify the battery.
- Do not touch any terminals or connectors.
- Please make sure any battery charger or charge controller has been disconnected before working on the battery.
- Do not connect or disconnect terminals from the battery without first disconnecting loads.
- Do not place tools on top of the battery.
- Please use suitable handling equipment for safe transportation of the battery.
- Do not insert foreign objects into the positive and negative terminals of the battery.

Renogy Support

To discuss inaccuracies or omissions in this quick guide or user manual, visit or contact us at:

[G | renogy.com/support/downloads](https://renogy.com/support/downloads)

 contentservice@renogy.com

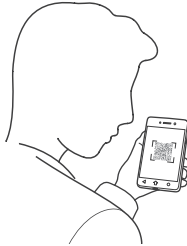

Questionnaire Investigation



To explore more possibilities of solar systems, visit Renogy Learning Center at:

[G | renogy.com/learning-center](https://renogy.com/learning-center)

For technical questions about your product in the U.S., contact the Renogy technical support team through:

[G | renogy.com/contact-us](https://renogy.com/contact-us)

 1(909)2877111

For technical support outside the U.S., visit the local website below:

[Canada | !\[\]\(b792654f2cef9719eabeb6c5be00811e_img.jpg\) ca.renogy.com](https://ca.renogy.com)

[China | !\[\]\(7d1d6890825e83a6a4a51febe2dcc7f3_img.jpg\) www.renogy.cn](https://www.renogy.cn)

[Australia | !\[\]\(2bae76de5ebbd5c4d7d47162f1673734_img.jpg\) au.renogy.com](https://au.renogy.com)

[Japan | !\[\]\(b64b40baaee5acddc1eab8538ba84754_img.jpg\) jp.renogy.com](https://jp.renogy.com)

[Other Europe | !\[\]\(84f47badaad7772cd95667a7c387a639_img.jpg\) eu.renogy.com](https://eu.renogy.com)

[Germany | !\[\]\(28f72b996fc97883dfd9d4e8b1b16b4e_img.jpg\) de.renogy.com](https://de.renogy.com)

[United Kingdom | !\[\]\(5d954b3e270654ad8ab0d5913161c03c_img.jpg\) uk.renogy.com](https://uk.renogy.com)

Join Our Facebook Community Today. Scan the QR code to connect with like-minded people and Renogy engineers. You will get:

- Priority access to our latest launches & special events
- Insider Q&A sessions with our engineers
- Endless solar project ideas & sources



Battery Recycling

The proper disposal and recycling of batteries are essential for environment protection and circular economy. We encourage correctly disposing of your batteries when they become depleted.

You can dispose your used batteries at any of [Call2Recycle](#) or [Earth911](#) locations that accepts Renogy rechargeable Lithium-ion and Lead-acid batteries (AGM&GEL).

 | www.call2recycle.org/locator



 | search.earth911.com



Enjoy our community's incentive program when you properly dispose of your batteries. You can earn \$20 gift cards to purchase any products on our website by participating. It's a simple way to be environmentally responsible and be rewarded for recycling.

 | renogy.com/support



FCC Statement

This device complies with Part 15 of the FCC Rules. Operation is subject to the following two conditions:

- (1) This device may not cause harmful interference.
- (2) This device must accept any interference received, including interference that may cause undesired operation.

This equipment has been tested and found to comply with the limits for a Class B digital device, pursuant to Part 15 of the FCC Rules. These limits are designed to provide reasonable protection against harmful interference in a residential installation. This equipment generates, uses and can radiate radio frequency energy and, if not installed and used in accordance with the instructions, may cause harmful interference to radio communications. However, there is no guarantee that interference will not occur in a particular installation. If this equipment does cause harmful interference to radio or television reception, which can be determined by turning the equipment off and on, the user is encouraged to try to correct the interference by one or more of the following measures:

- (1) Orient or relocate the receiving antenna.
- (2) Increase the separation between the equipment and receiver.
- (3) Connect the equipment into an outlet on a circuit different from that to which the receiver is connected.
- (4) Consult the dealer or an experienced radio/TV technician for help.

FCC Radiation Exposure Statement

This equipment complies with FCC radiation exposure limits set forth for an uncontrolled environment. This equipment should be installed and operated with minimum distance 20cm between the radiator & your body.

IC Warning

This device complies with Industry Canada's licence-exempt RSS standard(s). Operation is subject to the following two conditions:

- (1) this device may not cause interference, and
- (2) this device must accept any interference, including interference that may cause undesired operation of the device.

Le présent appareil est conforme aux CNR d'Industrie Canada applicables aux appareils radio exempts de licence. L'exploitation est autorisée aux deux conditions suivantes:

- (1) l'appareil n' doit pas produire de brouillage, et
- (2) l'utilisateur de l'appareil doit accepter tout brouillage radioélectrique subi, même si le brouillage est susceptible d'en compromettre le fonctionnement.

This Class B digital apparatus complies with Canadian ICES-003. Cet appareil numérique de la classe B est conforme à la norme NMB-003 du Canada.

IC RF Statement: When using the product, maintain a distance of 20cm from the body to ensure compliance with RF exposure requirements.



Renogy Empowered

Renogy aims to empower people around the world through education and distribution of DIY-friendly renewable energy solutions.

We intend to be a driving force for sustainable living and energy independence.

In support of this effort, our range of solar products makes it possible for you to minimize your carbon footprint by reducing the need for grid power.



Live Sustainably with Renogy

Did you know? In a given month, a 1 kW solar energy system will...



Save 170 pounds of coal from being burned



Save 300 pounds of CO₂ from being released into the atmosphere



Save 105 gallons of water from being consumed



Renogy Power PLUS

Renogy Power Plus allows you to stay in the loop with upcoming solar energy innovations, share your experiences with your solar energy journey, and connect with like-minded people who are changing the world in the Renogy Power Plus community.



@Renogy Solar



@renogyofficial



@Renogy

Renogy reserves the right to change the contents of this manual without notice.

Manufacturer: RENOGY New Energy Co.,Ltd
Address: No.66, East Ningbo Road Room 624-625 Taicang German
Overseas Students Pioneer Park JiangSu 215000 CN



eVatmaster Consulting GmbH
Battinastr. 30
60325 Frankfurt am Main, Germany
contact@evatmaster.com

Manufacturer: RENOGY New Energy Co.,Ltd
Address: No.66, East Ningbo Road Room 624-625 Taicang German
Overseas Students Pioneer Park JiangSu 215000 CN



EVATOST CONSULTING LTD
Office 101 52 Threadneedle Street,
London, United Kingdom, EC2R 8AY
contact@evatost.com

