



Your 4x4 Accessory Adventure Partner.

FITTING INSTRUCTIONS

XEB-SSG-01 SSANGYONG MUSSO

Q200 12/2021+









BEFORE INSTALLATION



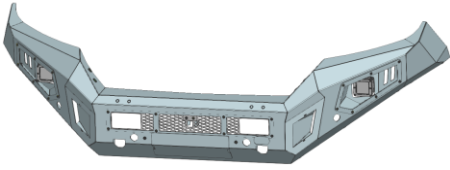
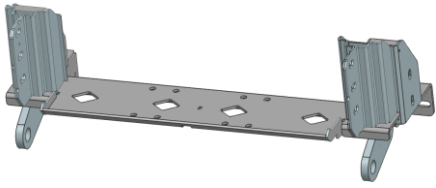
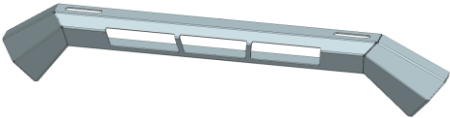

- Please read the instructions completely before installing. This will allow for easy installation and help to avoid scratches or other potential damages to the vehicle.
- Images are for reference only and may differ slightly from the actual product you are installing. Whilst images may differ, they share the same assembly instructions.

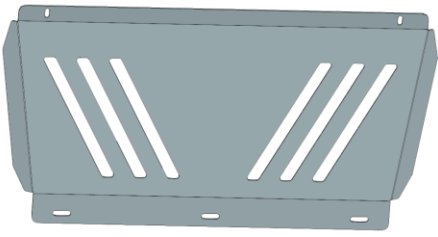

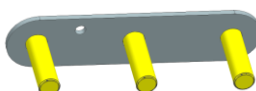
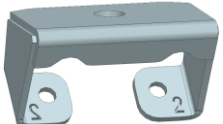

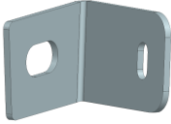
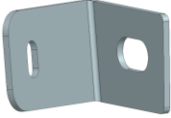
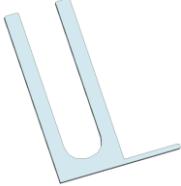

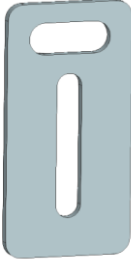
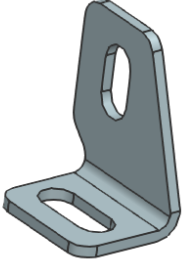
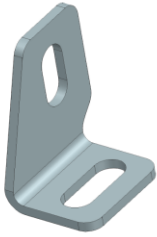

CARE & CLEANING

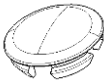
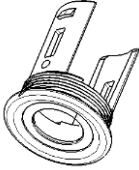

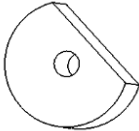
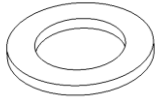

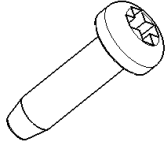





- Mild soap may be used to clean the bullbar.
- Check and retighten all the hardware regularly.

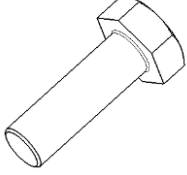

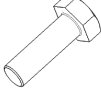

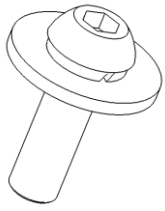
PARTS LIST

NO.	QTY	NAME	NO.	QTY	NAME
1	1	 Bull Bar Main body	2	1	 Winch Frame
3	1	 Lightbar Hoop	4	1	 Central Skid Plate
5	1	 Skid Plate(L)	6	1	 Skid Plate(R)
7	1	 Rear Central Skid Plate	8	1	 Foldable license plate bracket
9	2	 Bolt Plate	10	2	 Light Bar Bracket

11	2	 <p>Support Bracket</p>	12	1	 <p>Skid Plate Bracket (L)</p>
13	1	 <p>Skid Plate Bracket (R)</p>	14	8	 <p>Shim plate</p>
15	2	 <p>Crush Tube</p>	16	2	 <p>Oil Pipe Bracket</p>
17	1	 <p>Light Holder (L)</p>	18	1	 <p>Light Holder (R)</p>
19	1	 <p>Wire Harness for LED lights</p>			

Sensor relocation kits					
20	4	 Cover	21	4	 Holder
22	4	 M31x1.5 Lock Ring	23	4	 Foam Packer
24	12	 Foam Ring (D25_d15.5)	25	4	 Base
26	8	 Lock Screw ST4_15 ST4_15			
Hardware List					
27	1	 4mm Allen Key	28	3	 Spring Washer D8
29	12	 Spring Washer D12	30	3	 Large Washer D8(8x24x2mm)

31	18	 Large Washer D12(12x37x3mm)	32	12	 Hex Nut M12
33	16	 Hex Flange Nut M6	34	3	 Hex bolt(full thread) M8_16
35	2	 Hex bolt(full thread) M12_120	36	4	 Hex bolt(full thread) M12_110
37	2	 Hex Screw and washer combo M8_25	38	31	 Dome head bolt and Washer 18mm_ M6_20
Top bar Hardware list					
39	1	 5mm Allen Key	40	8	 Spring Washer D8
41	10	 Large Washer D8(8x24x2mm)	42	2	 Domb Head Bolt M8_16

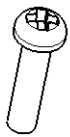
43	6	 <p>Dome Head bolt M8_25</p>	44	2	 <p>Hex Nut M8</p>
45	4	 <p>Hex Flange Nut M8</p>			
Foldable License Bracket hardware list					
46	8	 <p>Flat Washer D4(4x8.65x0.8mm)</p>	47	4	 <p>Hex Nut M4</p>
48	4	 <p>Pan Head Bolt M4_16</p>			

INSTALLATION

Step 1: Park vehicle on level surface.

Step 2: Remove 12 x scrivenets from top cover.



Step 3: Remove 2 x scrivenets and 4 x bolts from top of grille.



Step 4: Remove 4 x scrivenets from each wheel arch and lightly pull to unclip plastic trim.



Step 5: Remove 4 x 12mm bolts and remove bash guard.

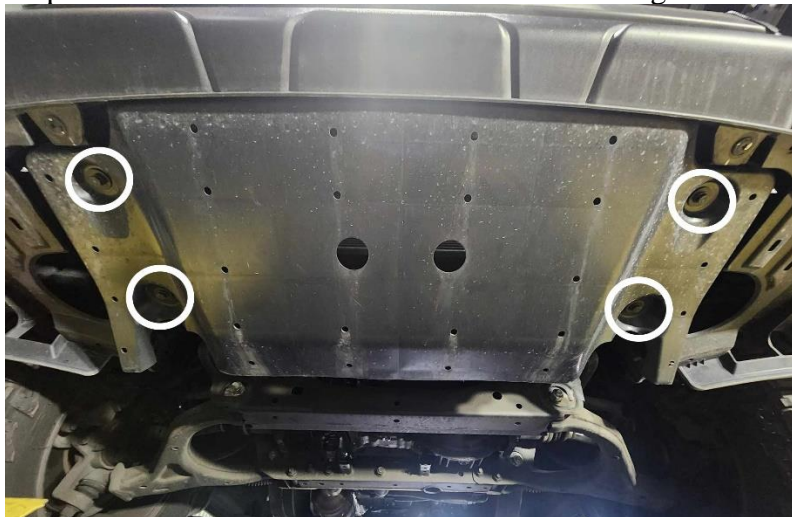

Step 6: Remove 3 x scrivenets from left and right underside of bumper bar.



Step 7: Remove 2 x scrivenets from centre underside of bumper bar.



Step 8: Lightly pull on corners to unclip and remove bumper bar and grille (Make sure to unplug wiring harness on passenger side in process of removing bar)



Step 9: Remove 4 x 16mm bolts and 2 x 12mm bolts and remove crash bar.

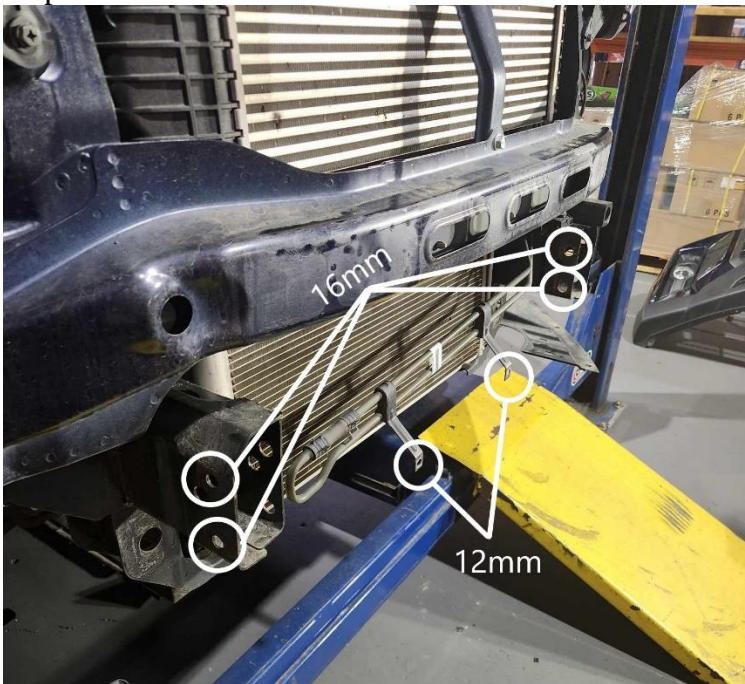

Step 10: Remove 4 x phillips head screws and remove side bumper brackets.



Step 11: Attach oil pipe and skid plate support brackets to the winch frame.

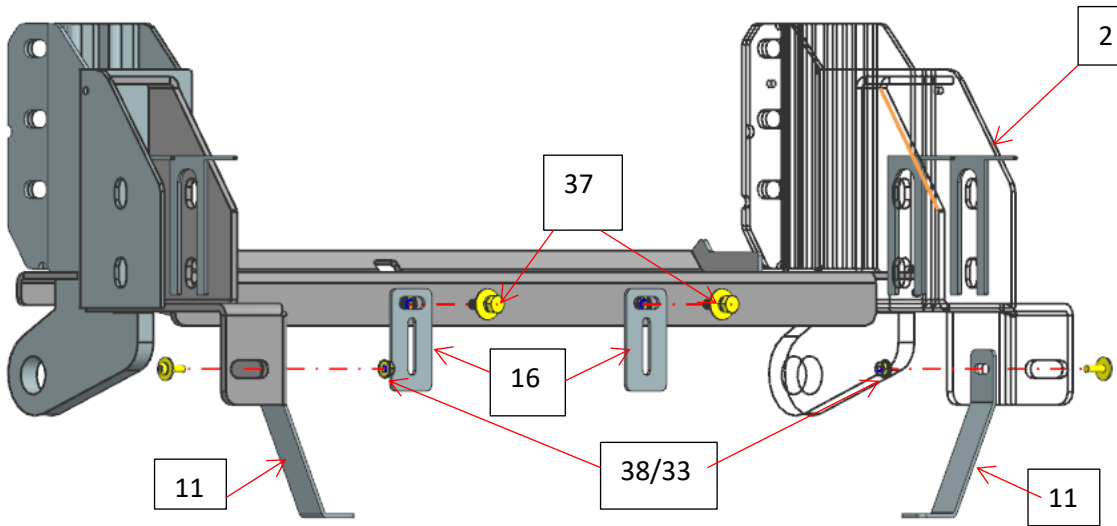

Step 12: Install the winch frame brackets with required hardware as shown

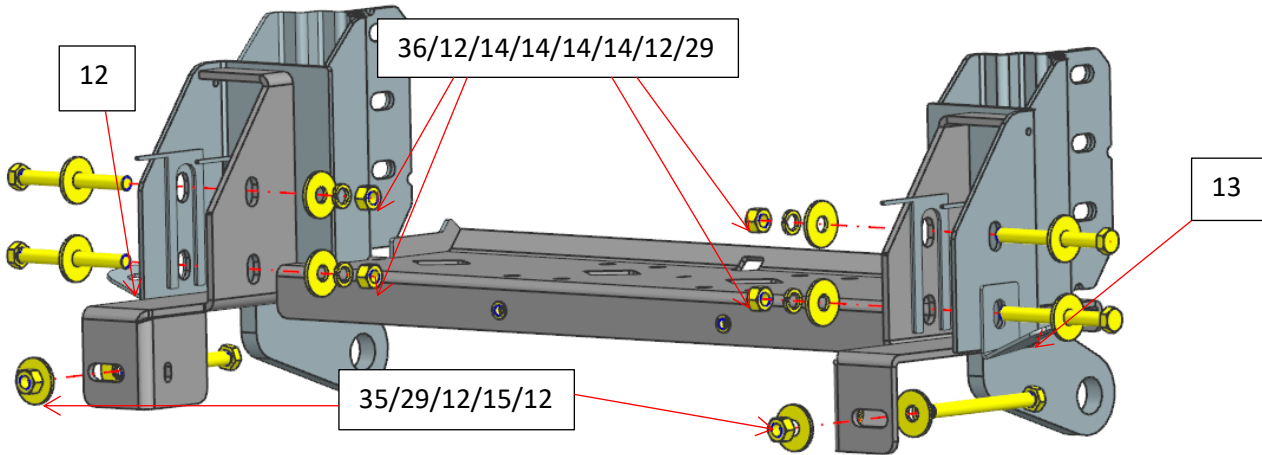

Side View

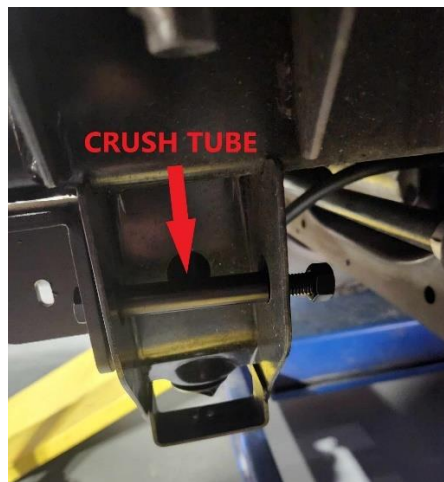

Side view with shims being installed

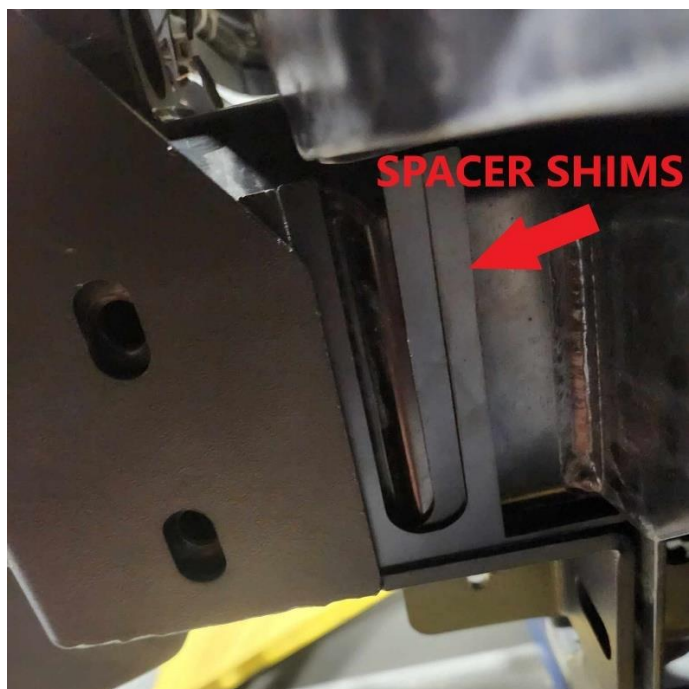

Skid plate bracket installed

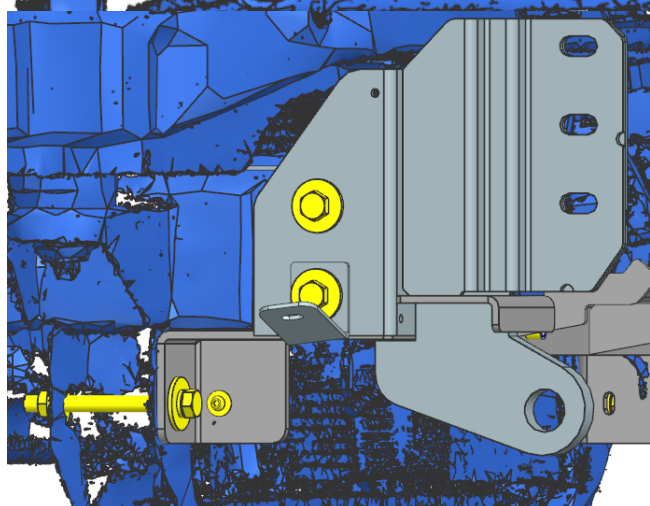
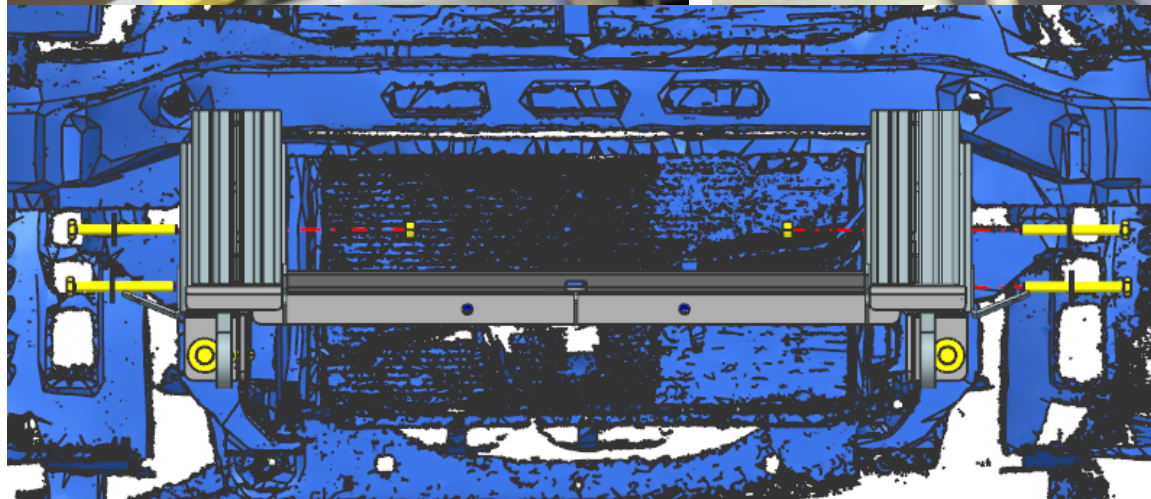

Step 13: Install oil pipe to the rear of winch frame as shown.

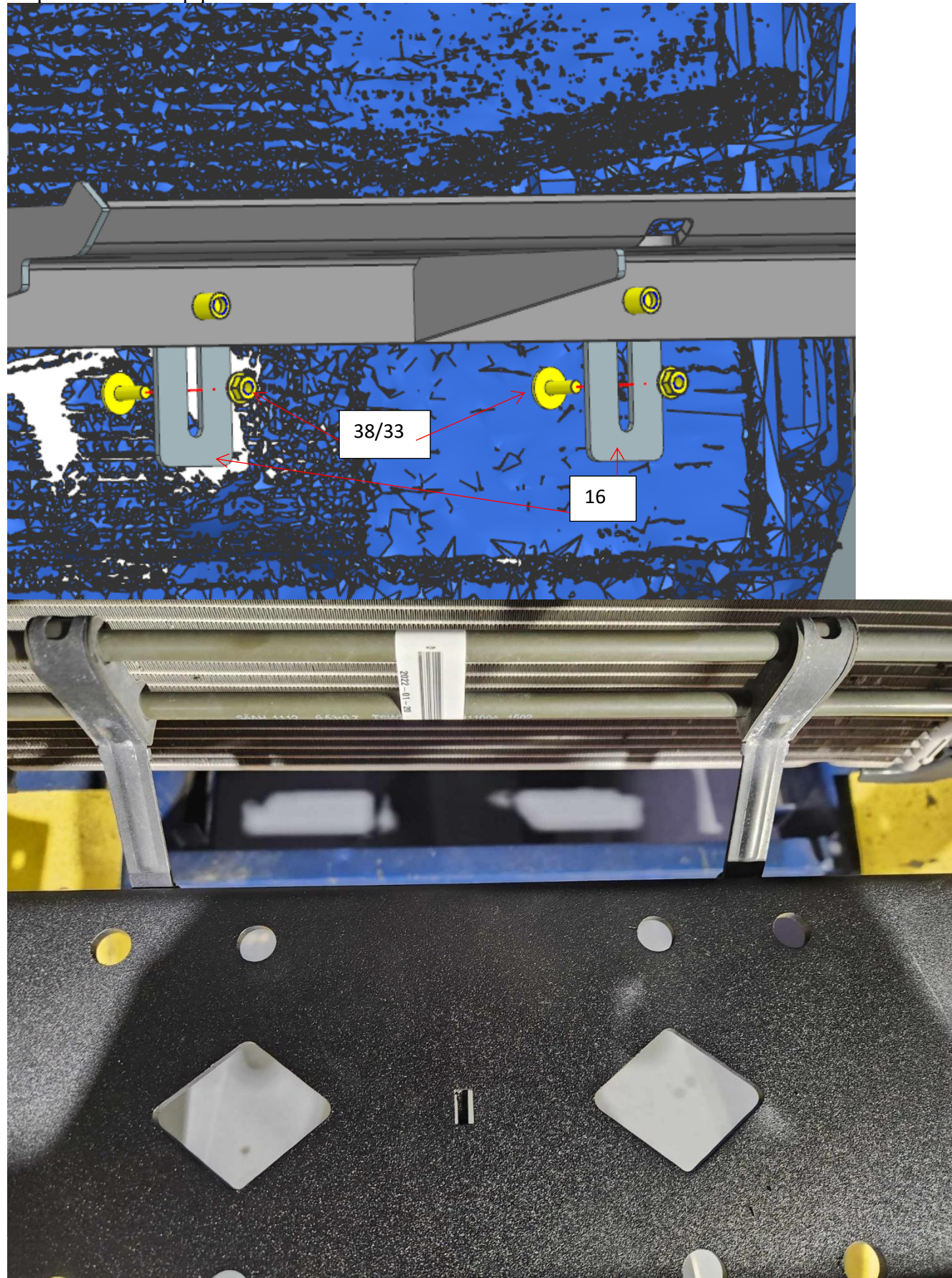

Step 14: Cut bottom grille support from the original bumper and reinstall onto the vehicle.



Step 15: Install parking sensors and wiring harness into the main bullbar assembly. You will need to trim down the sensor holder as shown for the sensors to fit. You will need to solder the supplied fog light plug onto the original harness.

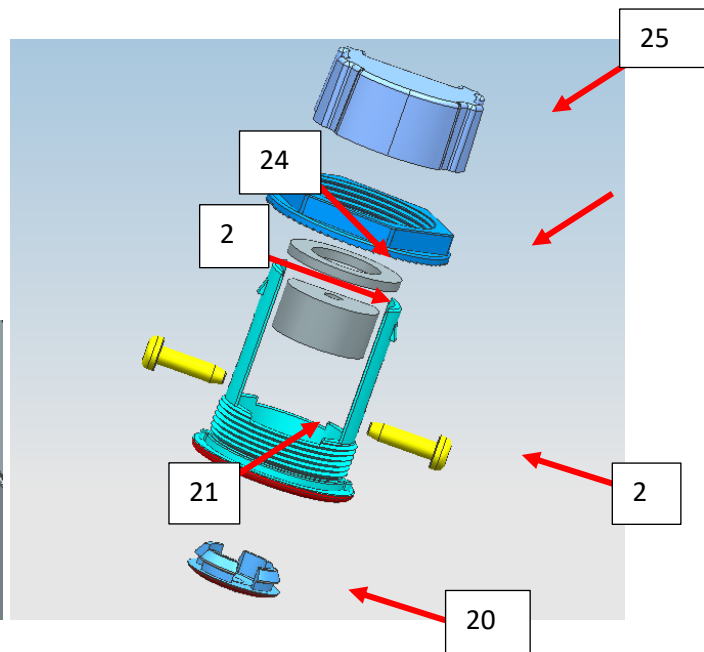
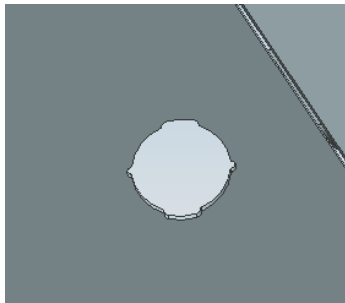

Step 16: Remove the front camera from the original grille. Fit the camera to the supplied bracket and install in the rear centre of the main bullbar assembly.

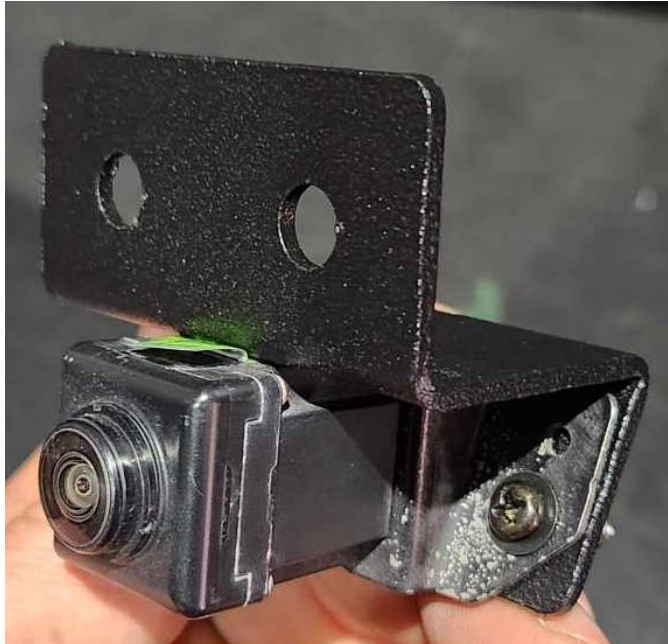

Step 16: Trim grille along the line as shown below



Trim each side of the grill as shown below. Grille can be refitted to the vehicle after trimming



Step 17: Trim wheel arch trim so it is flush with the vehicle body as shown.



If you are fitting a winch. Proceed with this before going any further.

Step 18: (Optional) Fit the lightbar hoop with required hardware as shown.

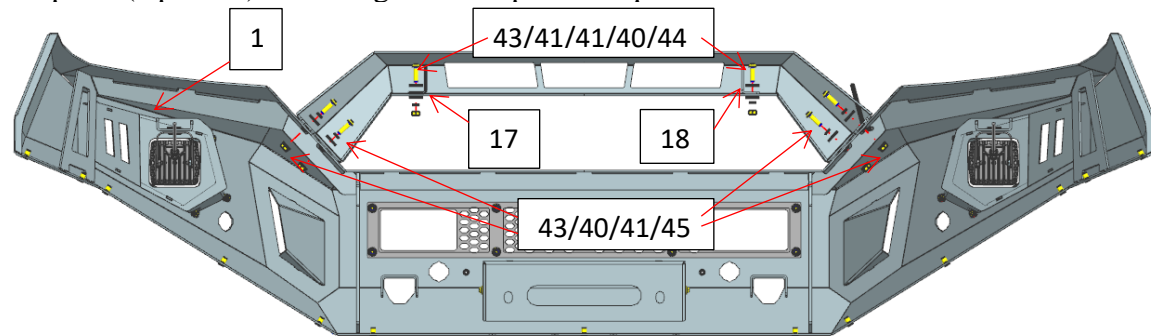

Lightbar fitment

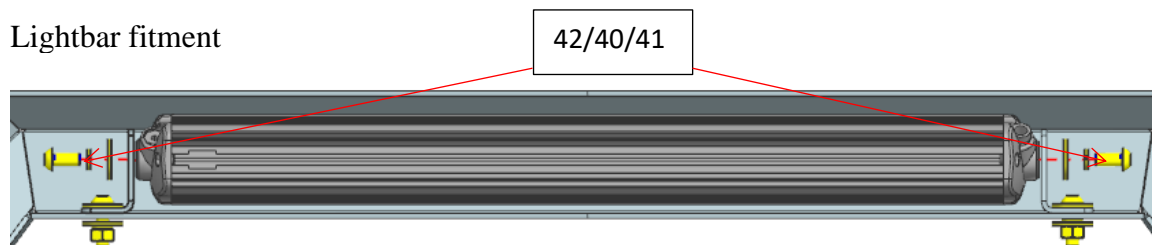

Step 19: Attach main bullbar assembly to winch frame with required hardware.

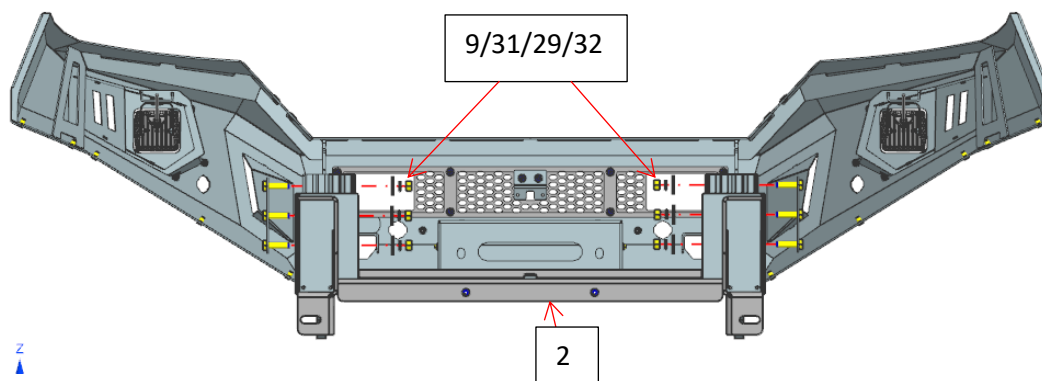

Step 20: Install skip plates with required hardware as shown below

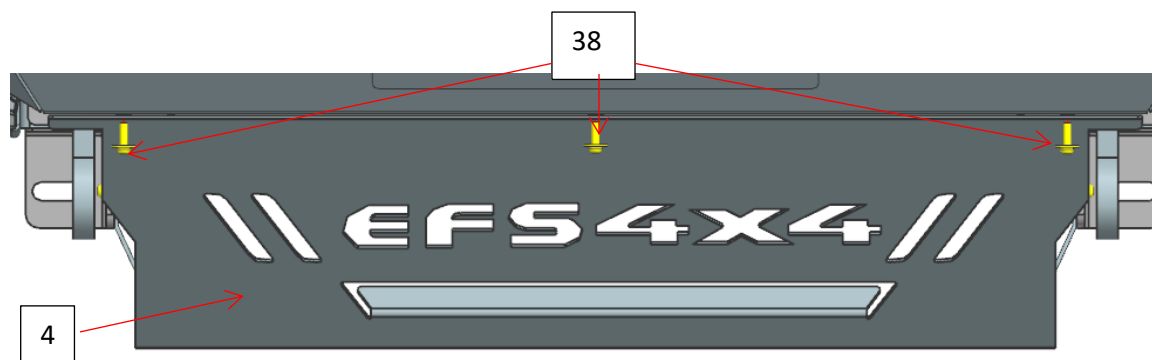
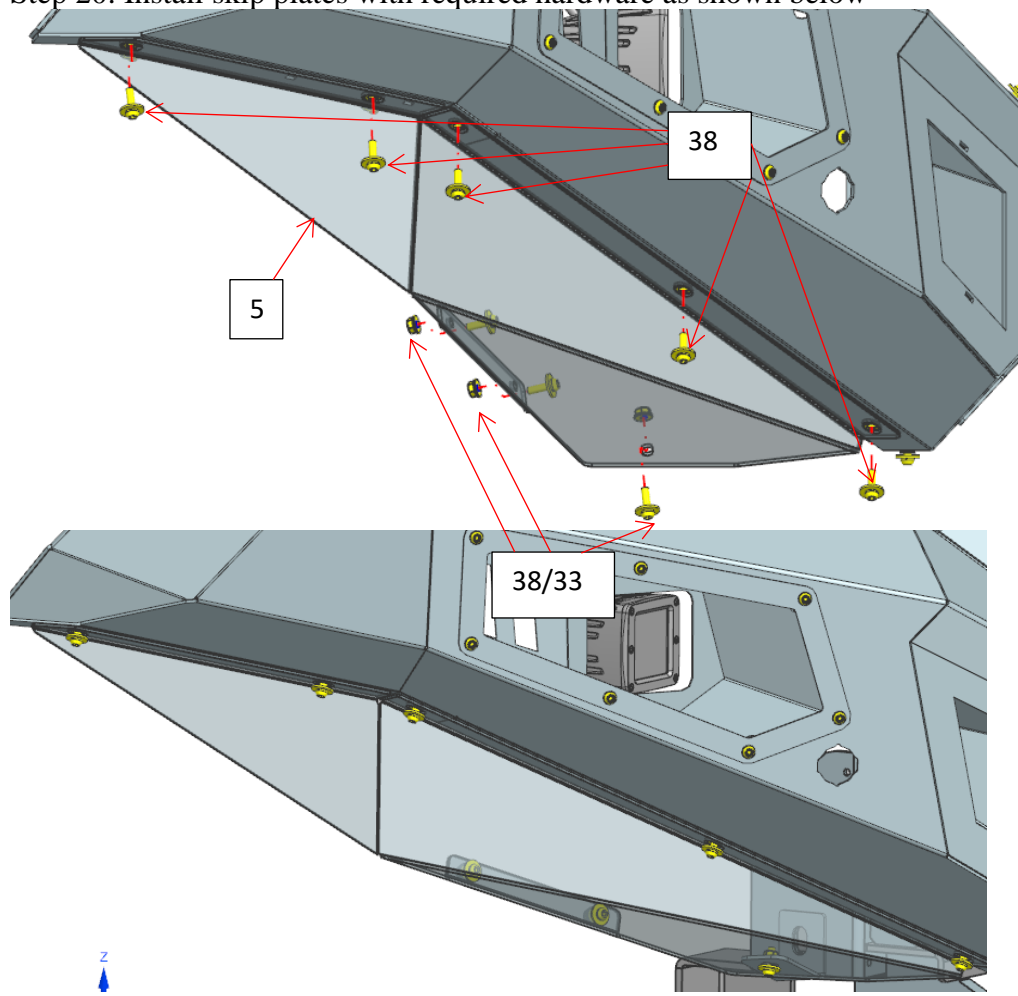

Step 21: Install the rear central skid plate as shown

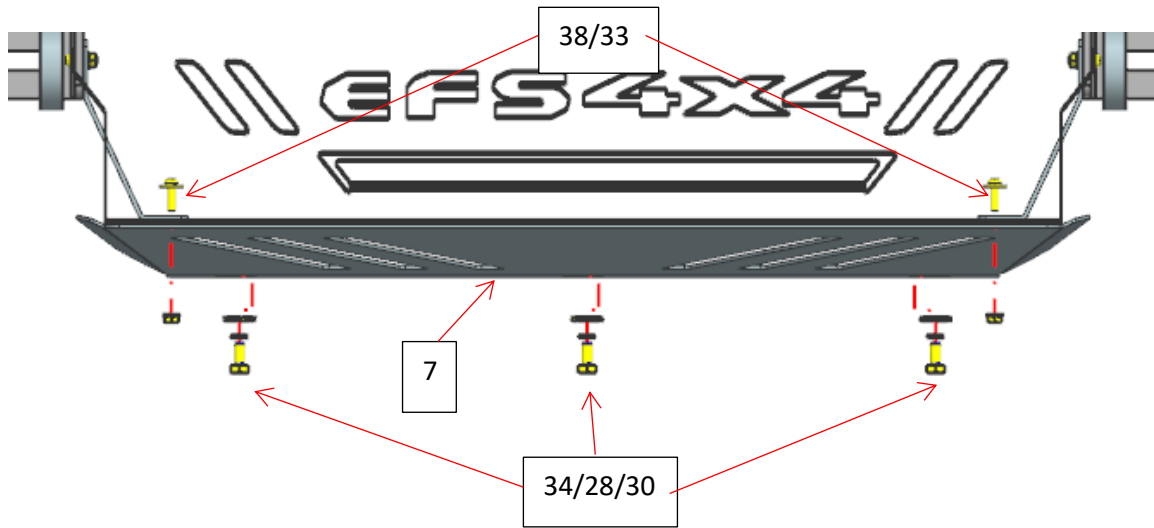

Step 22: Install license plate bracket with required hardware as shown below.

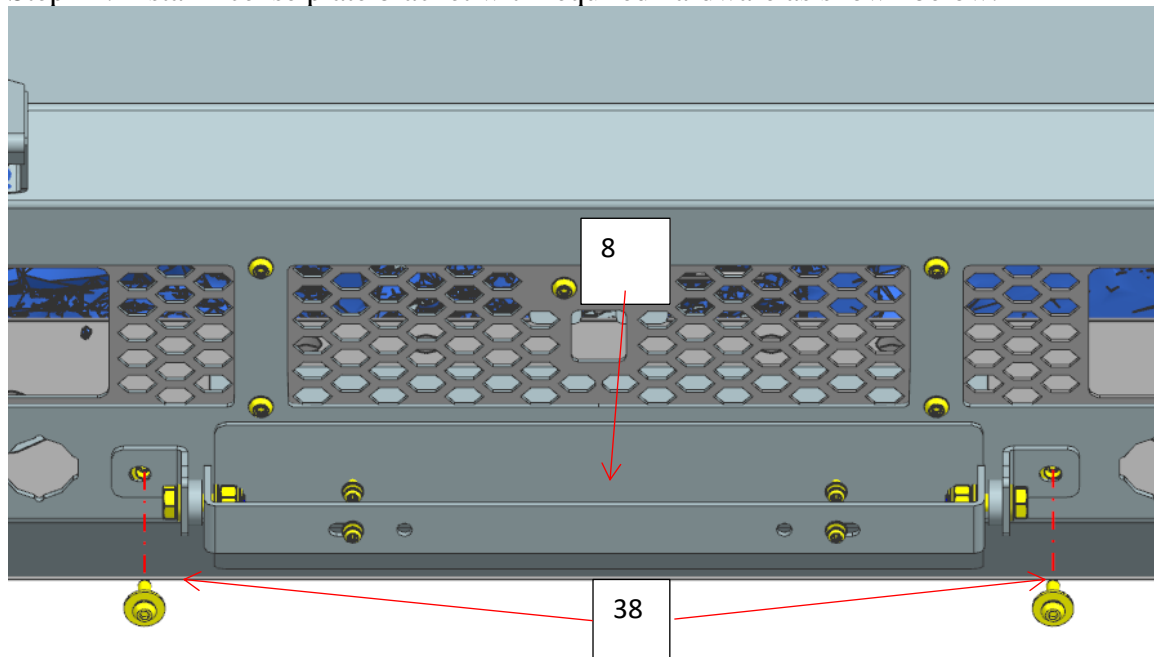

Test and make sure that the guard is steadily fixed, fully tighten all hardware.

Installation is finished, pick up all tools.

NOTE

Any damages or loss caused by the improper installation and use of EFS Accessories will not be covered by warranty.